

Attachment A12

Civil Engineering Statement

Canva

8-24 KIPPAX STREET, SURRY HILLS

CIVIL ENGINEERING DEVELOPMENT APPLICATION REPORT



Prepared for: Canva
By: enstruct group pty ltd
Revision: 02
December 2023

8-24 KIPPAX STREET, SURRY HILLS

CIVIL ENGINEERING DEVELOPMENT APPLICATION REPORT

ISSUE AUTHORISATION

PROJECT: 8-24 Kippax Street, Surry Hills

Project No: 7039

Rev	Date	Purpose of Issue / Nature of Revision	Prepared by	Reviewed by	Issue Authorise by
01	01/12/23	Draft Issue for DA	MZV	PAL	PAL
02	07/12/23	Issue for DA	MZV	PAL	PAL

This report is the property of enstruct group pty ltd, and is licensed to the Client for use on this project. Reproduction of this document for this project shall only be undertaken in full. Reproduction for other purposes without the permission of enstruct group pty ltd is prohibited.

Executive Summary

This Development Application Civil Engineering report has been prepared by enstruct Group to accompany the Development Application (DA) for a comprehensive refurbishment and fit out of the building located at 8-24 Kippax Street, Surry Hills (the site). The development will result in a commercial office space for Canva, the client.

This report has been prepared to address various aspects of civil design, including stormwater discharge quality and quantity including Onsite Stormwater Detention (OSD), flood planning, and erosion and sedimentation control.

This report concludes that the proposed mixed use commercial development is suitable and warrants approval subject to the implementation of the following mitigation measures:

- Erosion and sediment control measures,
- Stormwater quality measures, and
- Adopting a flood planning level in line with City of Sydney's Interim Flood Management Plan.

Contents

1	Introduction	1
1.1	Design Standards	1
2	Site Description	1
2.2	Existing Stormwater Drainage	2
3	Stormwater Drainage Design	2
3.1	On-site Stormwater Detention (OSD)	2
3.2	Flooding	2
3.3	Overland Flow Paths.....	4
3.4	Stormwater Quality	4
3.4.1	MUSIC Model.....	5
4	Erosion and Sediment Control	5
5	Conclusion	5
	APPENDIX A	1
	APPENDIX B	2
	APPENDIX C	3
	APPENDIX D	4

1 Introduction

enstruct Group have been engaged by Canva as Civil engineering consultants for the refurbishment works at 8-24 Kippax Street, Surry Hills. The upgrade and refurbishment works may include but are not limited to:

- Strip out of the existing fit out back to cold shell,
- Loading Dock relocation,
- External upgrades, including façade,
- Rooftop terrace,
- New End Of Trip (EOT) facility,
- Base building services upgrades including fire safety, central MEP, lift replacement, structural enhancements, security upgrades etc., and

1.1 Design Standards

The civil design shall be in accordance with the latest revision of all relevant civil Australian Standards, relevant civil sections of the BCA and other statutory requirements.

Particularly, the civil design will be in accordance with the following relevant Australian Standards:

- Sydney Development Control Plan (DCP) 2012
- Sydney Local Environmental Plan (LEP) 2012
- City of Sydney Interim Floodplain Management Policy (2014)
- Austroads: Guide to Pavement Technology
- AS1428.1 Design for Access & Mobility
- AS/NZS 2890 Parking facilities
- AS/NZS 3500.3 (2021) – Plumbing and Drainage Part 3: Stormwater Drainage
- AS 3600 (2018) – Concrete Structures
- AS 3700 (2011) – Masonry Code
- Australian Rainfall and Runoff (ARR 2019)
- Managing Urban Stormwater: Soils and construction - Volume 1 4th edition (Landcom)

2 Site Description

The subject site is located 8-24 Kippax Street, Surry Hills, and falls within the Local Government Area (LGA) of City of Sydney (CoS). The site is bound by Sophia Street to the north, Terry Street to the west, Kippax Street to the south, and a commercial building to the east. The site is approximately 100m from Central Station. The Terry Street frontage grades steeply to the north, and Kippax Street and Sophia Street grade to the west.

The existing building consists of a nine-storey commercial building with an additional two basement levels. It was built in the 1960's and last underwent refurbishment in the 1990's. The site area is approximately 1,034m², however, the commercial office space totals around 8,500m².

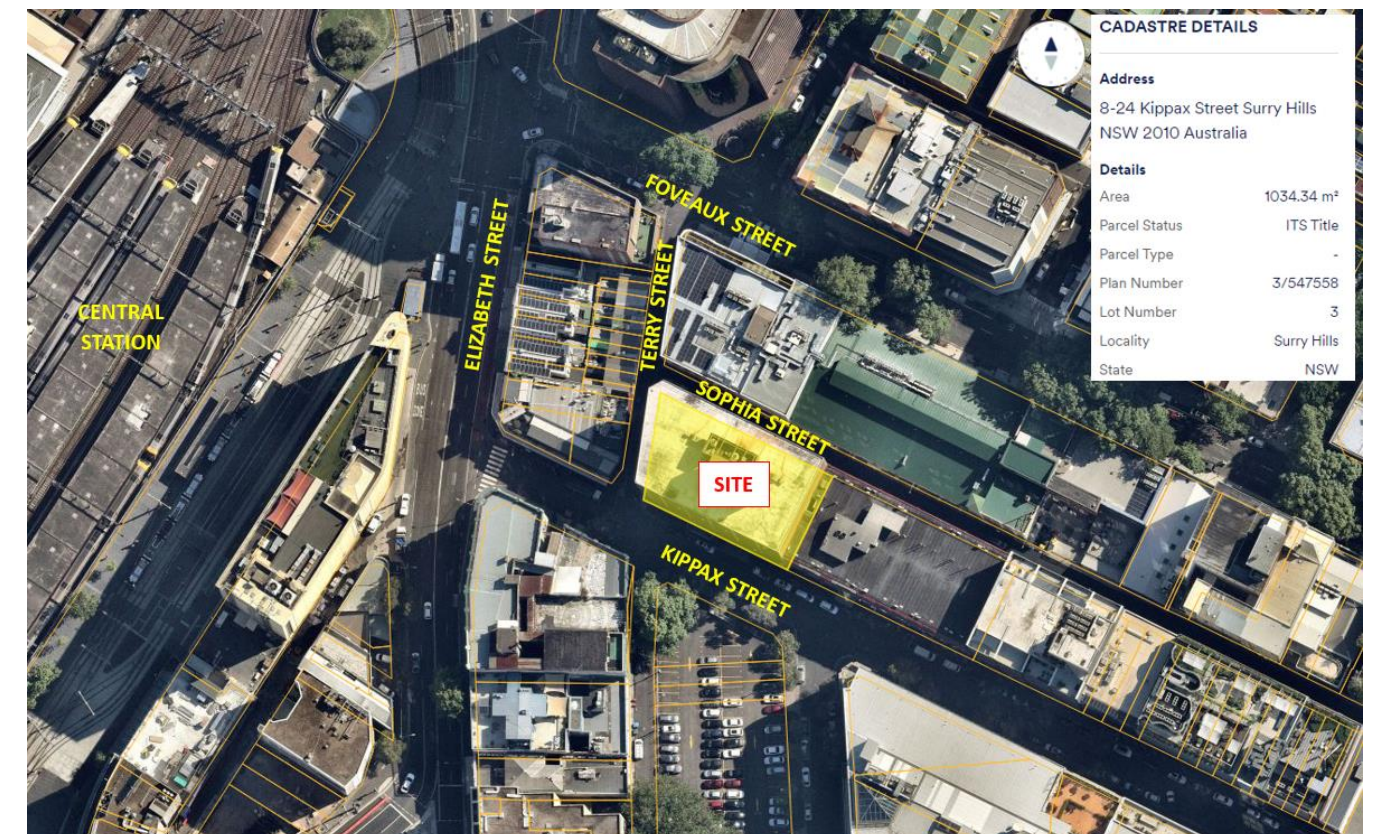

Figure 1: Subject Site (Source: NearMaps)

2.2 Existing Stormwater Drainage

City of Sydney stormwater mapping provided through Dial Before You Dig indicates the Council stormwater network surrounding the site. The Council network run through both Kippax Street and Sophia Street, adjacent to the site. There is an existing stormwater pit at the north-west corner of the site. Refer to **Figure 2**.

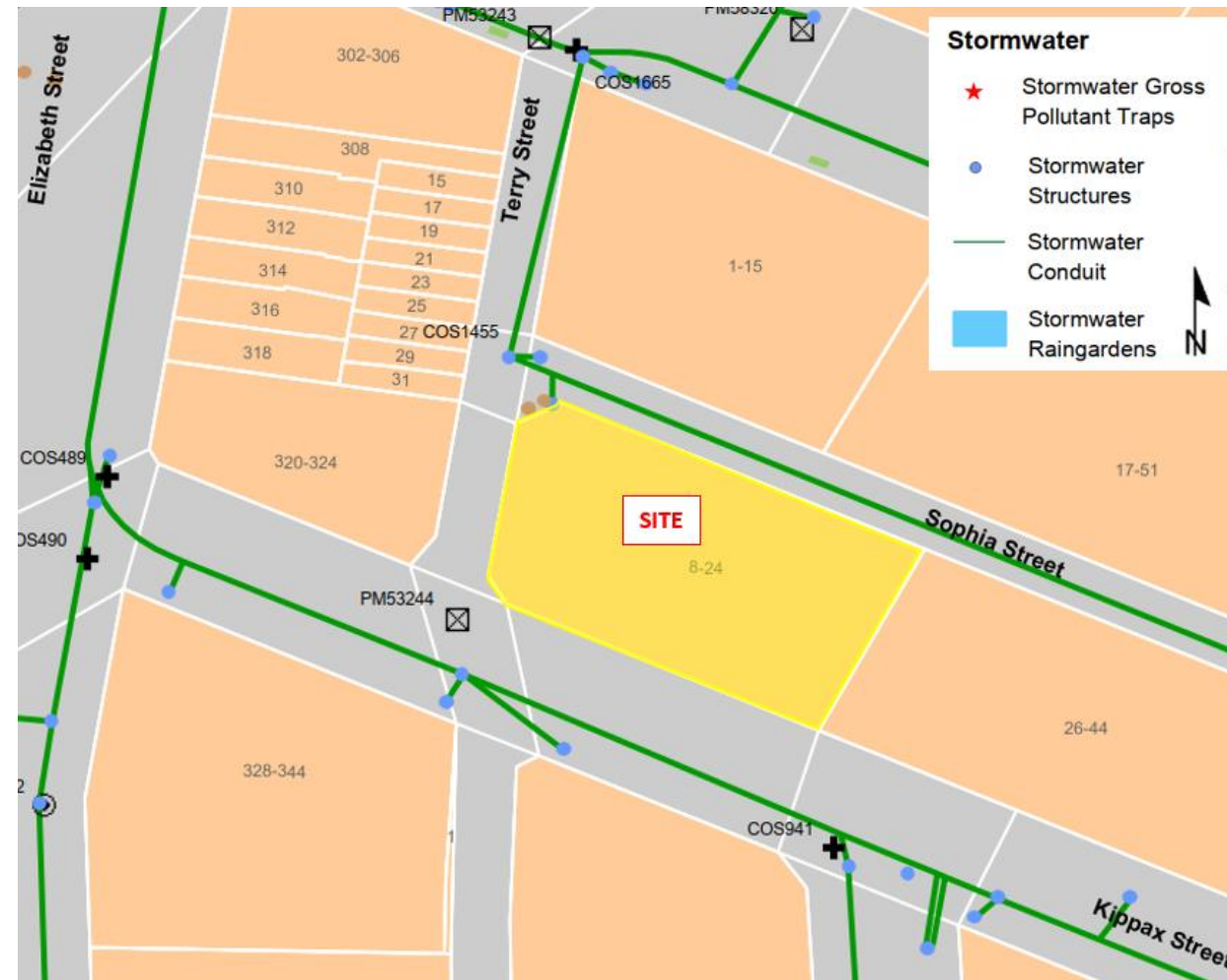

Figure 2: City of Sydney Council Stormwater Network (Source: City of Sydney Council)

3 Stormwater Drainage Design

The stormwater design has been prepared in accordance with Australian Standards, Sydney Development Control Plan, and Australian Rainfall and Runoff (2019). In general, drainage is designed to ensure that site facilities are available for visitors and staff to use in all weather conditions up to the 1% Annual Exceedance Probability (AEP) storm event. All new roof stormwater will be collected in roof gutters and downpipes and conveyed to the water quality control tank.

Pipes and pits have been designed to satisfy the minimum provisions of AS 3500.3. They have been designed to convey, at least, the 5% AEP flows. Where pipe capacity is exceeded i.e., greater than 5% AEP, stormwater will be conveyed as overland flow.

Overland flow paths are designed to convey at the minimum 1% AEP stormwater flows with a Velocity x Depth to be less than 0.4m²/s.

Class D pits have been specified in accordance with AS 3996.

3.1 On-site Stormwater Detention (OSD)

Correspondence with Sydney Water on 16th of October 2023 has indicated no OSD is required for any development at the site. Refer to **Appendix A** for this correspondence.

3.2 Flooding

The site is in the CoS Darling Harbour catchment as per **Figure 3**. CoS Council have undertaken a flood study covering the Darling Harbour Catchment. The flood study, including the TuFLOW model, has been obtained by enstruct in order to identify the Flood Planning Levels for the site.



Figure 3: City of Sydney Flood Catchment Mapping (Source: City of Sydney)

The flood study and TuFLOW model show the site is flood affected in the 1% Annual Exceedance Probability (AEP) and Permissible Maximum Flood (PMF) events. The TuFLOW model was updated to use the 2019 ARR Rainfall Data. The model indicates flood depths between 100mm-500mm surrounding the property in the 1% AEP event, and flood depths between 200mm-800mm in the PMF event. Refer to the figures below.

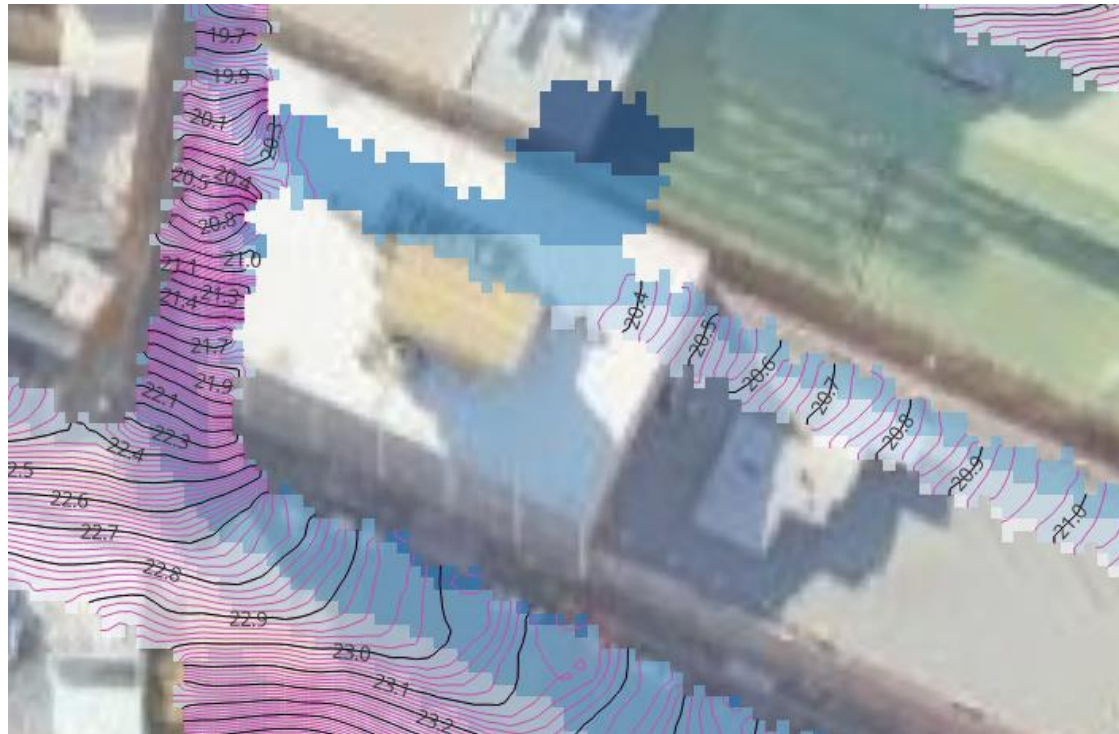

Figure 4: Site Flood Map 1% AEP (2019 ARR Rainfall Data)



Figure 5: Site Flood Maps PMF

The site is classed as a “business” development type and hence, the flood planning levels described in **Table 1** apply. The entries marked in orange in indicate a basement ingress point, and the entries marked in purple indicate all other building entries.

Table 1: City of Sydney Flood Planning Levels

Development	Type of Flooding	Flood Planning Level
Business Floor Levels	Mainstream or local drainage flooding	Merits approach presented by the applicant with a minimum of the 1% AEP flood level
Below Ground Car Park	Mainstream or local drainage flooding	1% AEP flood level + 0.5m or the PMF (whichever is higher) *

* The below ground car park level applies to all possible ingress points to the car park such as vehicle entrances and exits, ventilation ducts, windows, light wells, lift shaft openings, risers, and stairwells.

All points of entry on the lower ground level, as per **Figure 6**, and on the ground level as per **Figure 7**, have sought to meet the Flood Planning Levels (FPL) described in **Table 1**. **Table 2** shows a summary of the FPLs, flood levels, and proposed design at each entry point.

Table 2: Flood Planning Level Comparison

Entry					
Point	1% AEP Level (AHD)	1% AEP Level + 500mm (AHD)	PMF Level (AHD)	FPL (AHD)	Proposal
1	20.52m	21.02m	20.88m	21.02m	Flood Door
2	20.50m			20.50m	FFL: 20.515m
3	20.46m			20.46m	FFL: 20.495m
4	20.42m			20.42m	FFL: 20.495m
5	20.40m			20.40m	FFL: 20.405m
6	20.40m			20.40m	FFL: 20.405m
7	20.38m			20.38m	FFL: 20.403m
8	20.38m			20.38m	FFL: 20.398m
9	20.38m			20.38m	FFL: 20.393m
10	20.38m			20.38m	FFL: 20.385m
11	20.38m			20.37m	FFL: 20.377m
12	20.38m			20.37m	FFL: 20.371m
13	20.34m			20.34m	FFL: 20.218m
14	23.15m			23.15m	FFL: 23.282m
15	23.15m	23.65m	23.38m	23.65m	Flood Door
16	23.12m			23.12m	FFL: 23.400m

At entry point 13 it is unfeasible to raise the floor level to the FPL, however, as this is the existing condition there is no proposed adverse effects to the site, its neighbouring properties, or any increased risk to life. Further, the floor level steps up above the FPL within the first room. All flooring below the FPL will be constructed of flood compatible materials, and any hazards, such as electrical sockets, will be located above the FPL.

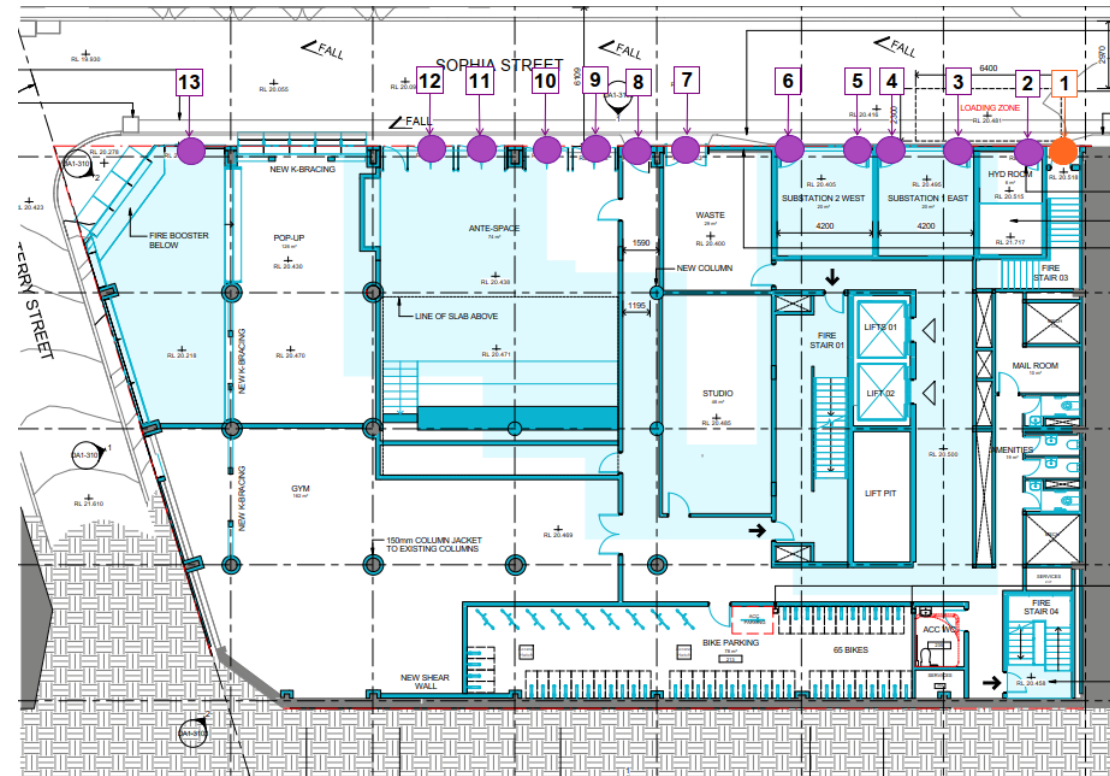

Figure 6: Lower Ground Entry Point Map (Source: COX)

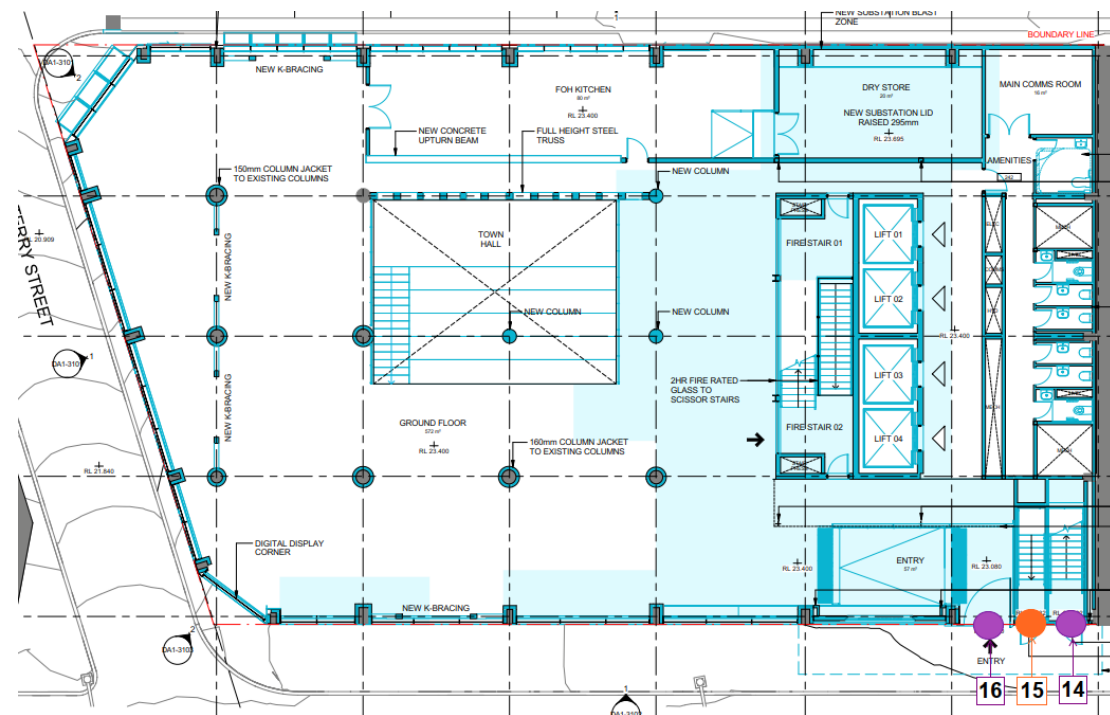

Figure 7: Upper Ground Entry Point Map (Source: COX)

Overall, the development meets the performance criteria described in the CoS Interim Flood Management Plan. The development is compatible with the established flood hazard of the land, will not significantly adversely affect flood behaviour, the environment, or cause avoidable erosion, incorporates appropriate measures to manage risk to life, is not likely to result in great costs, is consistent with the principles of Ecologically Sustainable Development, and adequately considers the impact of climate change.

Additional sketches of the flood levels around the site are available in **Appendix C**.

3.3 Overland Flow Paths

If the piped in-ground stormwater system proposed in Sophia Street fails due to blockage or other obstruction, or in an event larger than the 20-year ARI event, stormwater flows will be required to be conveyed as overland flow. The overland flow is to be directed away from buildings and downstream along Council's system.

Overland flow paths will be sized to accommodate the 1% AEP storm flows and not exceed safe Depth x Velocity products of 0.4m²/s for pedestrians and vehicles.

3.4 Stormwater Quality

City of Sydney's DCP Part 3 describes the provisions for Water Sensitive Urban Design (WSUD), including water quality. Part 3 of the DCP requires all commercial developments of sites greater than 1,000m² to demonstrate that the development will achieve the post-development pollutant load standards described in **Table 3** below.

Table 3: Pollutant Load Reduction Requirements (Source: City of Sydney DCP)

Pollutant	Post-development reduction of Baseline Annual Pollutant Load
Gross pollutants	90%
Total suspended solids	85%
Total phosphorus	65%
Total nitrogen	45%

3.4.1 MUSIC Model

A MUSIC model was developed in accordance with the City of Sydney WSUD MUSIC Technical Guideline to indicate the suitability of the proposed WSUD measures on the site. The MUSIC model was set up using the City of Sydney MUSIC-Link with clay soil type as per the soil map provided by City of Sydney, **Figure 8**.

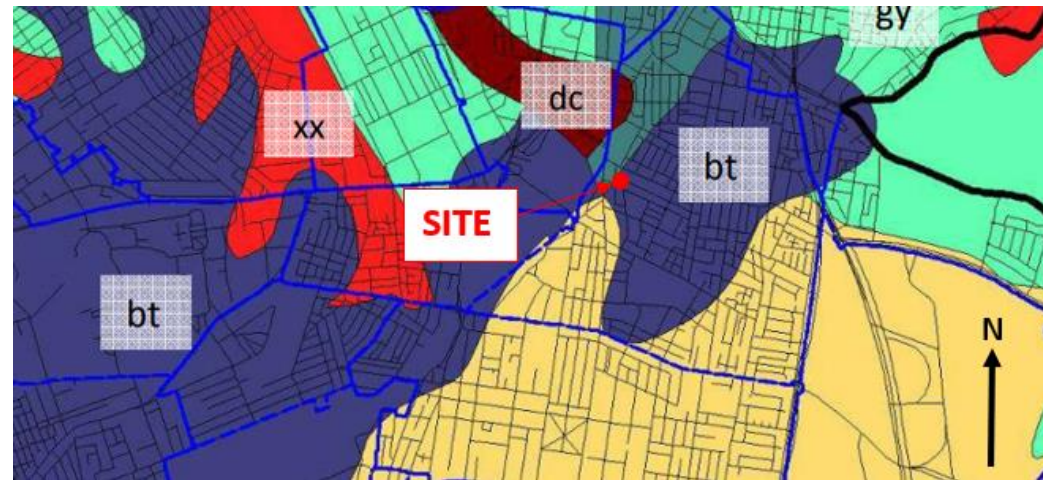

Figure 8: City of Sydney Soil Types (Source: City of Sydney WSUD MUSIC Technical Guideline)

The MUSIC model sought to decrease the annual pollutant load discharged from the site to the values described in **Table 3**. A comparison on the achieved reduction rates compared to the objectives is available in **Table 4** and further detail of the model is available in **Appendix B**. To achieve these reductions, the following water quality devices are proposed:

- A stormwater quality tank containing:
 - 1 x OceanGuard pit insert, and
 - 2 x 690mm StormFilters.
- A 6kL rainwater tank.

Table 4: Pollutant Reduction MUSIC Results Comparison

Pollutant	Post-development reduction of Baseline Annual Pollutant Load	Post-development reduction of Baseline Annual Pollutant Load result
Gross pollutants	90%	99%
Total suspended solids	85%	85.4%
Total phosphorus	65%	72.4%
Total nitrogen	45%	54.4%

4 Erosion and Sediment Control

During construction and while the site is disturbed, erosion prevention and sediment control measures will be required. Erosion prevention generally involves managing stormwater by diverting overland flow around construction areas as well as collecting stormwater within the construction zone and directing to sediment control devices. Devices likely to be incorporated are silt removal fences, catch drains, and water flow dissipation and discharge control devices such as sandbags, pollution mattresses and basins.

Erosion prevention and sediment removal strategies need to be inspected regularly during construction works, cleaned, and maintained after storm events, and modified to suit construction work progress, decanting, and demolition.

Erosion and sediment controls are to be maintained until the site is fully stabilised to prevent pollution of the receiving environment. The controls are to be designed, constructed, and installed in accordance with Managing Urban Stormwater: Soils and Construction Volume 1 and 2 (Blue Book Vol. 1 and 2), and North Sydney DCP.

5 Conclusion

The civil works associated with the refurbishment of Canva, Surry Hills will be carried out in accordance with normal engineering practice and will meet the requirements of relevant standards.

After correspondence with Sydney Water, the site will require not OSD. The site will however require stormwater quality control measures. The site will utilise a preliminary a combined tank including one pit insert and two StormFilter cartridges to reduce pollutants before discharge. This tank will work to remove pollutant loads alongside a rainwater tank, assumed to be 6kL in volume.

Due to the flood affectation of the property in both the 1% AEP and PMF flood events, Flood Planning Levels apply to floor levels and basement ingress points along the property frontages. Some areas have met the FPL; however, some areas require alternative methods such as flood barriers. Overall, the development meets the performance criteria required by CoS regarding flood management.

Erosion and sediment control measures are to be in place during construction to prevent contamination of the downstream stormwater system and tracking of grit and sediment onto the roadway.

APPENDIX A

Sydney Water Correspondence

Veitch, Mia

From: Jeya Jeyadevan <JEYA.JEYADEVAN@sydneywater.com.au>
Sent: Monday, 16 October 2023 1:40 PM
To: Mia Veitch
Cc: Phillip Lambley
Subject: RE: [External] 8-24 Kippax Street OSD Requirement

Mia,

Please ensure all future correspondence in relation to all stormwater enquires including On Site Detention requirements are sent to the following address:

stormwater@sydneywater.com.au

On Site Detention is not required for any development at this property 8-24 Kippax Street, Surry Hills.

Best Regards

Jeya Jeyadevan
Senior Capability Assessor
Business Development
Sydney Water, Level 13, 1 Smith Street, Parramatta NSW 2150

Sydney
WATER

Phone: 8849 6118
Mobile: 0409 318 827
jeya.jeyadevan@sydneywater.com.au

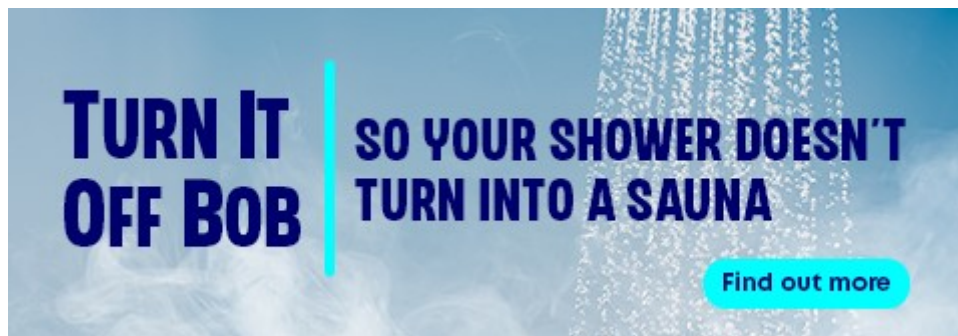

APPENDIX B

MUSIC Model & Outputs

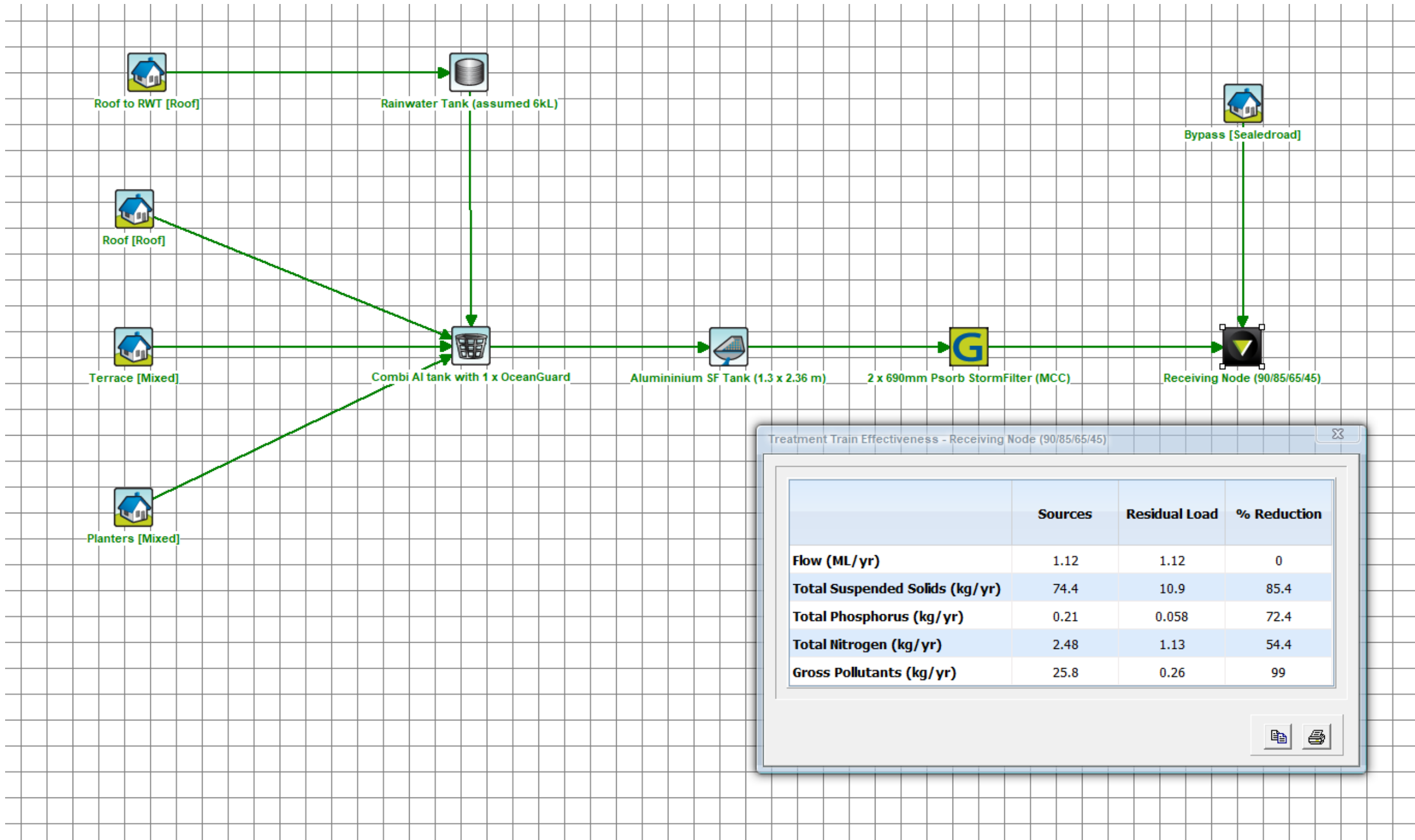

MUSIC-*link* Report

Project Details		Company Details	
Project:	8-24 Kippax Street, Surry Hills	Company:	enstruct
Report Export Date:	1/12/2023	Contact:	Mia Veitch
Catchment Name:	231201 - MUSIC Model - MZV	Address:	Level 4/2 Glen St, MIlsons Point NSW 2061
Catchment Area:	0.103ha	Phone:	(02) 8904 1444
Impervious Area*:	84.46%	Email:	Mia.Veitch@wsp.com
Rainfall Station:	66062 SYDNEY		
Modelling Time-step:	6 Mminutes		
Modelling Period:	1/01/1982 - 31/12/1986 11:54:00 PM		
Mean Annual Rainfall:	1278mm		
Evapotranspiration:	1265mm		
MUSIC Version:	6.3.0		
MUSIC-link data Version:	6.34		
Study Area:	City of Sydney Clay Soil		
Scenario:	City Of Sydney Development		

* takes into account area from all source nodes that link to the chosen reporting node, excluding Import Data Nodes

Treatment Train Effectiveness		Treatment Nodes		Source Nodes	
Node: Receiving Node (90/85/65/45)	Reduction	Node Type	Number	Node Type	Number
Flow	0.00018%	Sedimentation Basin Node	1	Urban Source Node	5
		Rain Water Tank Node	1		
		GPT Node	1		
		Generic Node	1		
TSS	85.4%				
TP	72.4%				
TN	54.4%				
GP	99%				

Comments

The aluminium SF tank inputs are as per manufacturers (OceanProtect) specification. For enquires please contact OceanProtect on 1300 354 722.

Passing Parameters

Node Type	Node Name	Parameter	Min	Max	Actual
GPT	Combi AI tank with 1 x OceanGuard	Hi-flow bypass rate (cum/sec)	None	99	0.04
Rain	Rainwater Tank (assumed 6kL)	% Reuse Demand Met	None	None	0
Receiving	Receiving Node (90/85/65/45)	% Load Reduction	None	None	0.00018
Receiving	Receiving Node (90/85/65/45)	GP % Load Reduction	90	None	99
Receiving	Receiving Node (90/85/65/45)	TN % Load Reduction	45	None	54.4
Receiving	Receiving Node (90/85/65/45)	TP % Load Reduction	65	None	72.4
Receiving	Receiving Node (90/85/65/45)	TSS % Load Reduction	85	None	85.4
Sedimentation	Aluminium SF Tank (1.3 x 2.36 m)	% Reuse Demand Met	None	None	0
Sedimentation	Aluminium SF Tank (1.3 x 2.36 m)	Exfiltration Rate (mm/hr)	0	0	0
Sedimentation	Aluminium SF Tank (1.3 x 2.36 m)	Extended detention depth (m)	0.25	1	0.77
Sedimentation	Aluminium SF Tank (1.3 x 2.36 m)	High Flow Bypass Out (ML/yr)	None	None	0
Urban	Bypass	Area Impervious (ha)	None	None	0.001
Urban	Bypass	Area Pervious (ha)	None	None	0
Urban	Bypass	Total Area (ha)	None	None	0.001
Urban	Planters	Area Impervious (ha)	None	None	0
Urban	Planters	Area Pervious (ha)	None	None	0.016
Urban	Planters	Total Area (ha)	None	None	0.016
Urban	Roof	Area Impervious (ha)	None	None	0.034
Urban	Roof	Area Pervious (ha)	None	None	0
Urban	Roof	Total Area (ha)	None	None	0.034
Urban	Roof to RWT	Area Impervious (ha)	None	None	0.034
Urban	Roof to RWT	Area Pervious (ha)	None	None	0
Urban	Roof to RWT	Total Area (ha)	None	None	0.034
Urban	Terrace	Area Impervious (ha)	None	None	0.018
Urban	Terrace	Area Pervious (ha)	None	None	0
Urban	Terrace	Total Area (ha)	None	None	0.018

Only certain parameters are reported when they pass validation

Failing Parameters

Node Type	Node Name	Parameter	Min	Max	Actual
Sedimentation	Aluminium SF Tank (1.3 x 2.36 m)	Notional Detention Time (hrs)	8	12	0.0708
Sedimentation	Aluminium SF Tank (1.3 x 2.36 m)	Total Nitrogen - k (m/yr)	500	500	1
Sedimentation	Aluminium SF Tank (1.3 x 2.36 m)	Total Phosphorus - k (m/yr)	6000	6000	1
Sedimentation	Aluminium SF Tank (1.3 x 2.36 m)	Total Suspended Solids - k (m/yr)	8000	8000	1

Only certain parameters are reported when they pass validation

APPENDIX C

Flood Level Sketches

LEGEND:

1% AEP RL: 20.00	1% AEP Flood Level
1% AEP RL: 20.00	PMF Flood Level

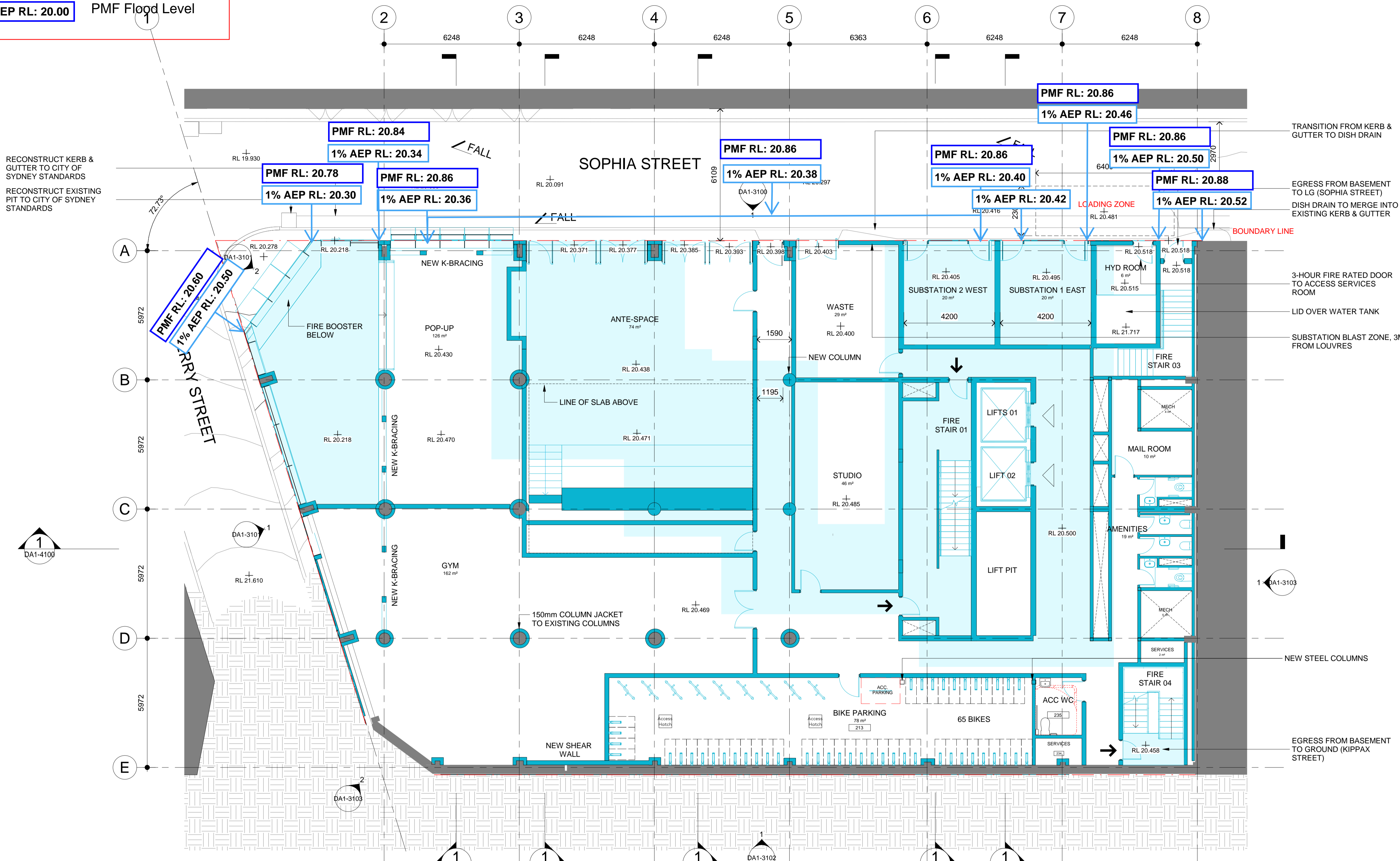

5 Flood Planning Levels

A Flood Planning Level refers to the permissible minimum building floor levels. For below-ground parking or other forms of below-ground development, the Flood Planning Level refers to the minimum level at each access point. Where more than one flood planning level is applicable the higher of the applicable Flood Planning Levels shall prevail.

Development	Type of flooding	Flood Planning Level
Industrial or Commercial	Business	Mainstream or local drainage flooding
Below-ground garage/ car park	All other below-ground car parks	Mainstream or local drainage flooding
		Merits approach presented by the applicant with a minimum of the 1% AEP flood level
		1% AEP flood level + 0.5 m or the PMF (whichever is the higher) See Note 1

© COPYRIGHT COX ARCHITECTURE PTY LTD ACN 002 535 891
 ANY FORM OF REPRODUCTION OF THIS DRAWING IN FULL OR IN PART WITHOUT THE WRITTEN PERMISSION OF COX ARCHITECTURE PTY LTD CONSTITUTES AN INFRINGEMENT OF COPYRIGHT

Rev	Description	By	Date
1	Issue For DA1 Submission	LV	05/12/2023

PROJECT MANAGER
 Level 13/25 Bligh St, Sydney NSW 2000
 GENERATE PROPERTY GROUP

STRUCTURAL ENGINEER
 486 Clarence St, Sydney NSW 2000
 +61 2 950 2680
 MEINHARDT

SERVICES ENGINEER
 33 Erskine St, Sydney NSW 2000
 +61 408 679 459
 ADP

TOWN PLANNER
 Level 4/180 George St, Sydney NSW 2000
 +61 410 291 014
 ETHOS URBAN

WASTE CONSULTANT
 Henry Lawson, Building, 408/19 Rossby St, Drummoyne
 +61 2 8541 6169
 MRA CONSULTING

TRAFFIC CONSULTANT
 10 Hesp St, Chesham NSW 2057
 +61 2 9285 1450
 TTPA

FAÇADE ENGINEER
 68 York St, Sydney NSW 2000
 +61 2 9285 1450
 SURFACE DESIGN

SPECIALIST FIRE ENGINEER / ESD
 Level 11, 10 Carrington Street, Sydney, NSW, 2000
 +61 447 343 458
 E-LAB CONSULTING

BCA CONSULTANT
 Suite 302, Level 3, 151 Castlereagh Street
 +61 2 9411 5360
 JENSEN HUGHES

LEGEND

- EXISTING BUILDING FABRIC
- NEW BUILDING FABRIC
- NEW SLAB INFILL AREA
- DEMOLISHED BUILDING FABRIC
- EXTENT OF SLAB DEMOLISHED
- EXTENT OF FAÇADE DEMOLISHED
- BOUNDARY LINE
- INDICATIVE SERVICES ZONE

GENERAL NOTES

DRAWINGS TO BE READ IN CONJUNCTION WITH REPORTS PREPARED FOR THE PURPOSE OF THIS DEVELOPMENT APPLICATION.
 BASE BUILT INFORMATION BASED ON SURVEY MODEL PROVIDED BY SURVEYOR.

Cox Architecture
 70 George Street
 The Rocks NSW 2000
 Australia
 T + 61 2 9267 9599
 coxarchitecture.com.au

Nominated Architects:
 Joe Agius no. 6491
 Russell Lee no. 6367



Client: CANVA

Project No.: 22058.0

Project: CANVA

8-24 KIPPAX STREET, SURRY HILLS

Acknowledgement: In the language of the Eora Nation people, this site is known as Gadigal land.

Drawing Title: GA PLAN - LOWER GROUND

enstruct

Status: FOR INFORMATION

Job Title: 8-24 Kippax Street, Surry Hills - Canva

Drawing Title: SITE FLOOD LEVELS

Scales: File Ref.

Dir: MZV Date: 07/12/23 Chd: PAL

Job No.: 7039 Dwg No.: CV-SK-001 Rev: C

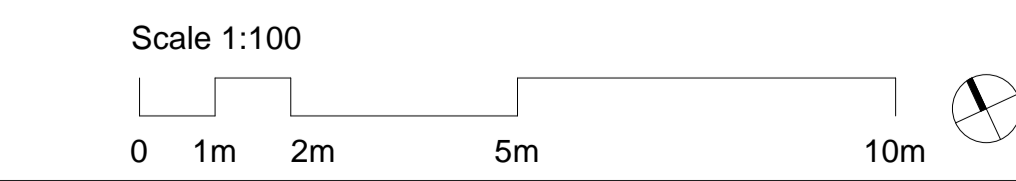

Document Control Status: DEVELOPMENT APPLICATION

Co-ordinated: LV Drawn: HC

Project Architect: LV Scale: 1:100 @ A1

Project Director: RJ Date: 05/12/2023

Drawing Number: DA1-2101 Revision: 1

LEGEND:

1% AEP RL: 20.00	1% AEP Flood Level
1% AEP RL: 20.00	PMF Flood Level

enstruct

Status: FOR INFORMATION

Job Title: 8-24 Kippax Street, Surry Hills - Canva

Drawing Title: SITE FLOOD LEVELS

Scales: File Ref.

Dr: MVZ Date: 07/12/23 Chd: PAL

Job No: 7039 Dwg No: CV-SK-001 Rev: C

© COPYRIGHT COX ARCHITECTURE PTY LTD ACN 002 535 891
 ANY FORM OF REPRODUCTION OF THIS DRAWING IN FULL OR IN PART WITHOUT THE WRITTEN PERMISSION OF COX ARCHITECTURE PTY LTD CONSTITUTES AN INFRINGEMENT OF COPYRIGHT

Rev	Description	By	Date
1	Issue For DA1 Submission	LV	05/12/2023

PROJECT MANAGER
 Level 13/25 Bligh St, Sydney NSW 2000
GENERATE PROPERTY GROUP

STRUCTURAL ENGINEER
 486 Clarence St, Sydney NSW 2000
 +61 2 9521 6500
MEINHART

SERVICES ENGINEER
 33 Erskine St, Sydney NSW 2000
 +61 408 679 459
ADP

TOWN PLANNER
 Level 4/180 George St, Sydney NSW 2000
 +61 410 291 014
ETHOS URBAN

WASTE CONSULTANT
 Henry Lawson, Building, 408/19 Rossby St, Drummoyne
 +61 2 8541 6169
MRA CONSULTING

TRAFFIC CONSULTANT
 10 West St, Chesham NSW 2057
 +61 2 9411 5660
TTPA

FAÇADE ENGINEER
 68 York St, Sydney NSW 2000
 +61 2 9248 1450
SURFACE DESIGN

SPECIALIST FIRE ENGINEER / ESD
 Level 11, 10 Carrington Street, Sydney, NSW, 2000
 +61 447 343 458
E-LAB CONSULTING

BCA CONSULTANT
 Suite 302, Level 3, 151 Castlereagh Street
 +61 2 9411 5360
JENSEN HUGHES

LEGEND

- EXISTING BUILDING FABRIC
- NEW BUILDING FABRIC
- NEW SLAB INFILL AREA
- DEMOLISHED BUILDING FABRIC
- EXTENT OF SLAB DEMOLISHED
- EXTENT OF FAÇADE DEMOLISHED
- BOUNDARY LINE
- INDICATIVE SERVICES ZONE

GENERAL NOTES

DRAWINGS TO BE READ IN CONJUNCTION WITH REPORTS PREPARED FOR THE PURPOSE OF THIS DEVELOPMENT APPLICATION.

BASE BUILT INFORMATION BASED ON SURVEY MODEL PROVIDED BY SURVEYOR.

Cox Architecture
 70 George Street
 The Rocks NSW 2000
 Australia
 T + 61 2 9267 9599
 coxarchitecture.com.au

Nominated Architects:
 Joe Agius no. 6491
 Russell Lee no. 6367



Client: CANVA

Project No: 22058.0

Project: CANVA

8-24 KIPPAX STREET, SURRY HILLS

Acknowledgement: In the language of the Eora Nation people, this site is known as Gadigal land.

Drawing Title: GA PLAN - GROUND LEVEL

Document Control Status: DEVELOPMENT APPLICATION

Co-ordinated:	LV	Drawn:	HC
Project Architect:	LV	Scale:	1 : 100 @ A1
Project Director:	RJ	Date:	05/12/2023
Drawing Number:	DA1-2102	Revision:	1

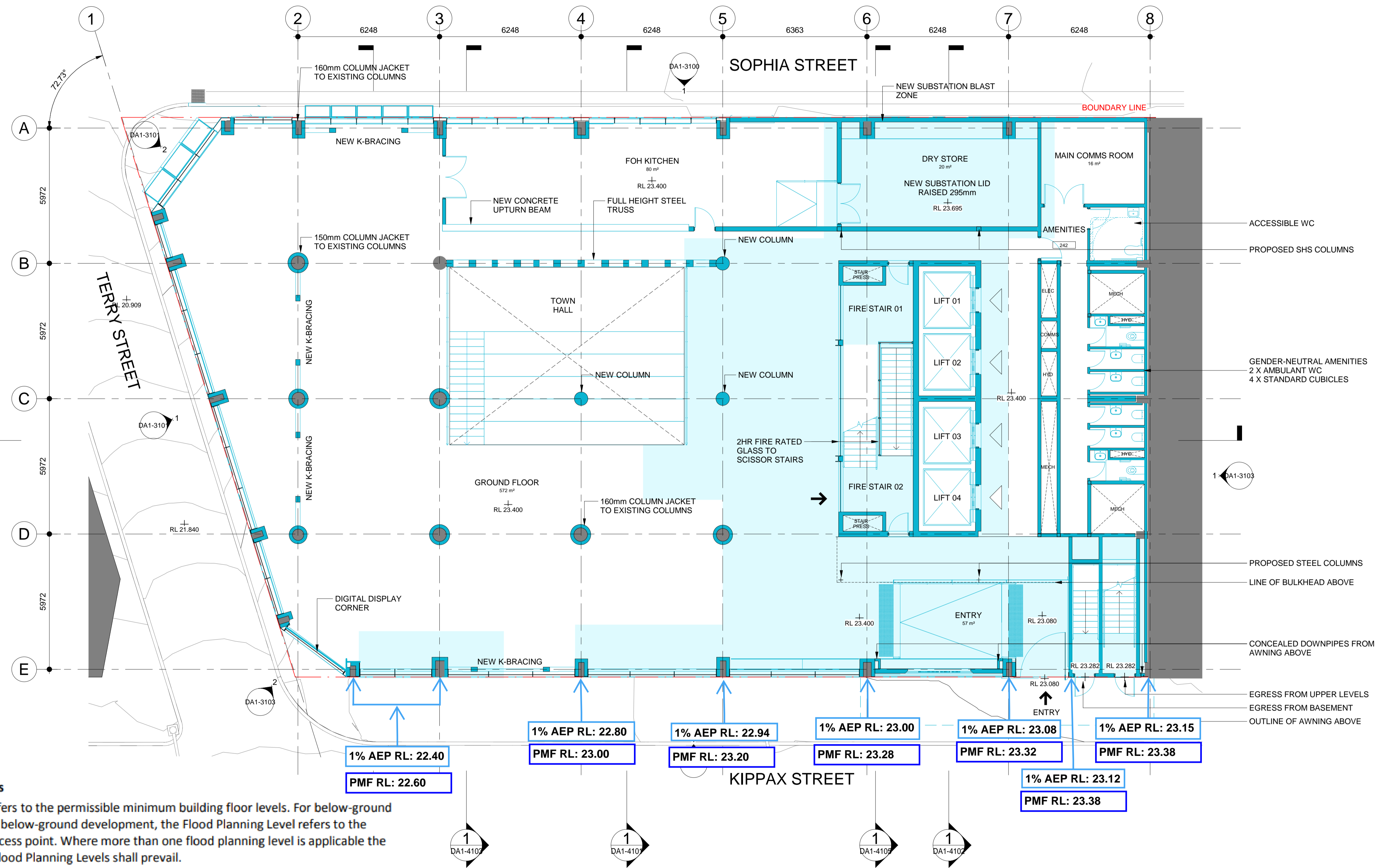

5 Flood Planning Levels

A Flood Planning Level refers to the permissible minimum building floor levels. For below-ground parking or other forms of below-ground development, the Flood Planning Level refers to the minimum level at each access point. Where more than one flood planning level is applicable the higher of the applicable Flood Planning Levels shall prevail.

Development	Type of flooding	Flood Planning Level
Industrial or Commercial	Business	Mainstream or local drainage flooding Merits approach presented by the applicant with a minimum of the 1% AEP flood level
Below-ground garage/ car park	All other below-ground car parks	1% AEP flood level + 0.5 m or the PMF (whichever is the higher) See Note 1

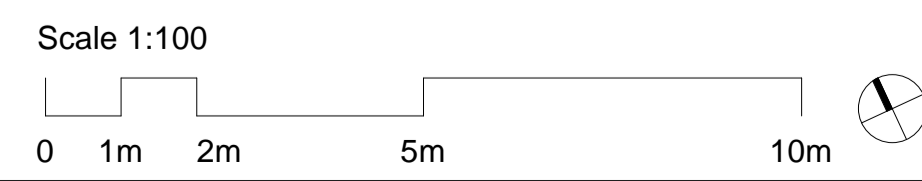

APPENDIX D

Civil Drawings

enstruct

CIVIL ENGINEERING WORKS

CANVA - SURRY HILLS

8-24 KIPPAX STREET, SURRY HILLS 2010

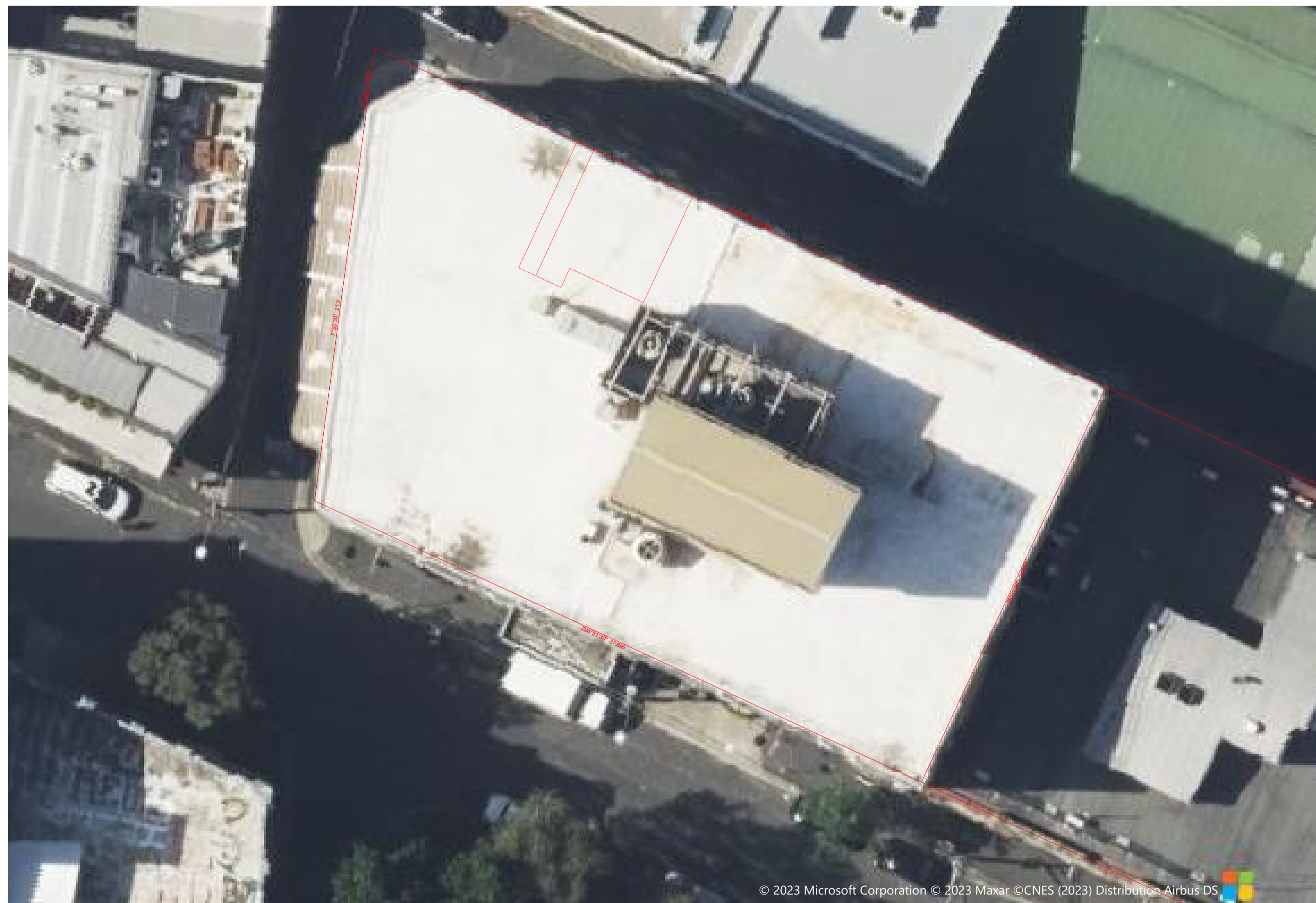

LOCALITY PLAN
SCALE: 1:200

© 2023 Microsoft Corporation © 2023 Maxar © CNES (2023) Distribution Airbus DS

CIVIL ENGINEERING WORKS DRAWING LIST:

- 7039-CV-0001 COVER SHEET, LOCALITY PLAN AND DRAWING LIST
- 7039-CV-0002 NOTES SHEET
- 7039-CV-2001 SITEWORKS PLAN
- 7039-CV-3001 STORMWATER PLAN
- 7039-CV-3051 STORMWATER CATCHMENT PLAN
- 7039-CV-3501 DETAILS SHEET 1

NOT FOR CONSTRUCTION

Date generated: 11/20/23 3:07:46 PM I:\TRANSPORT\ENSTRUCT\CAD\17000\7039\CIVIL\DRAWINGS\7039-CV-0001

TO BE PRINTED IN FULL COLOUR

rev	date	description	dwn	ch/k
01	01/12/23	ISSUE FOR DEVELOPMENT APPLICATION	MZV	PAL

rev	date	description	dwn	ch/k

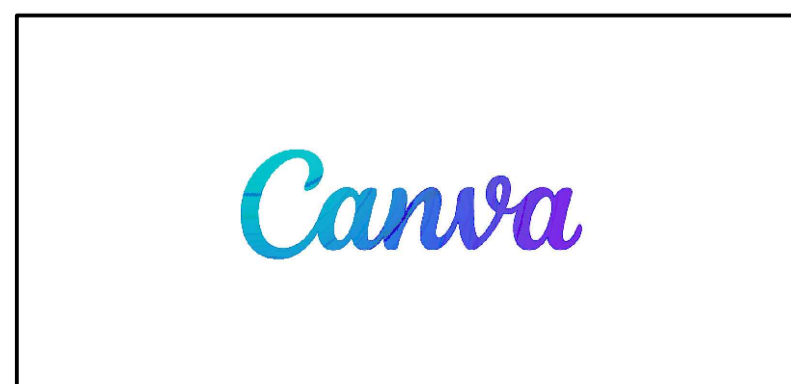

enstruct group pty ltd

Level 4, 2 Glen Street
Milsons Point NSW 2061
Australia

Telephone (02) 8904 1444
Facsimile (02) 8904 1555
www.enstruct.com.au



project	CANVA - SURRY HILLS
	8-24 KIPPAX STREET, SURRY HILLS 2010

drawing title	COVER SHEET, LOCALITY PLAN AND DRAWING LIST

status				FOR INFORMATION ONLY			
scale at A1	drawn	checked	approved				
N.T.S	MZV	PAL	DEC-23				
project no.	sheet		rev.				
7039	7039-CV-0001		01				

PAVEMENT LEGEND

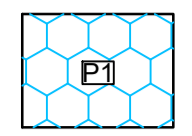
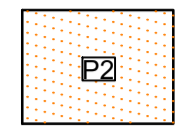
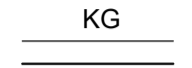
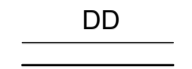
-  Pavement Type 1: Pavers to City of Sydney Specification.
-  Pavement Type 2: Pavers to City of Sydney Specification. Pavement constructed as a part of City of Sydney Terry Street Shared Zone.
-  PROPOSED KERB AND GUTTER
-  PROPOSED DISH DRAIN

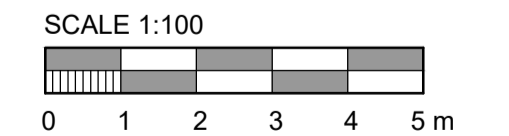

NOT FOR CONSTRUCTION

Date generated: 7/12/2023 8:48:22 AM | UTTRANSITIONENSTRUCTCAD0170007039CV001 | CIVILDRAWINGS\039-CV-2001

TO BE PRINTED IN FULL COLOUR

rev	date	description	drm	ch/k
03	07/12/23	ISSUE FOR DEVELOPMENT APPLICATION	MZV	PAL
02	01/12/23	ISSUE FOR DEVELOPMENT APPLICATION	BEJ	PAL
01	27/11/23	ISSUE FOR INFORMATION	BEJ	PAL

rev	date	description	drm	ch/k

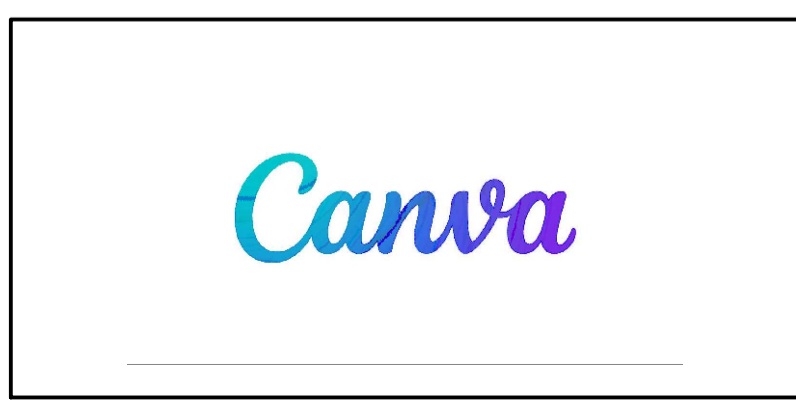

enstruct group pty ltd
 Level 4, 2 Glen Street
 Milsions Point NSW 2061
 Australia
 Telephone (02) 8904 1444
 Facsimile (02) 8904 1555
 www.enstruct.com.au



project
CANVA - SURRY HILLS
 8-24 KIPPAX STREET, SURRY HILLS 2010

drawing title
SITE WORKS PLAN

status			
FOR INFORMATION ONLY			
scale at A1 1:100	drawn MZV	checked PAL	approved NOV-23
project no. 7039	sheet 7039-CV-2001	rev. 03	

SITeworks LEGEND

- Property boundary
- Dish drain
- Proposed stormwater line and stormwater pit
- Concrete encased stormwater line
- Existing stormwater line
- Overland flow path

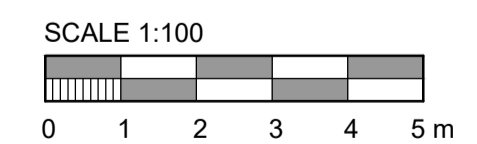

NOT FOR CONSTRUCTION

Date generated: 4/12/2023 11:27:25 AM | UTILITY/TRANSITION/STRUCTURE/03-CV-3001 | UTILITY/TRANSITION/STRUCTURE/03-CV-3001

TO BE PRINTED IN FULL COLOUR

rev	date	description	dm	ch/k
03	07/12/23	ISSUE FOR DEVELOPMENT APPLICATION	MZV	PAL
02	01/12/23	ISSUE FOR DEVELOPMENT APPLICATION	MZV	PAL
01	27/11/23	ISSUE FOR INFORMATION	BEJ	PAL

rev	date	description	dm	ch/k

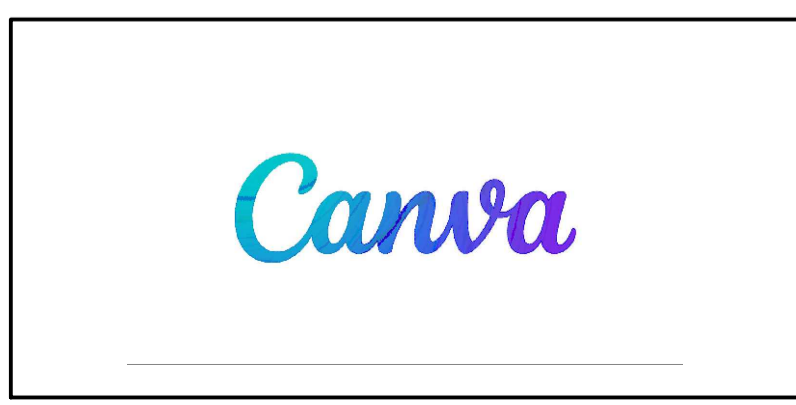

enstruct group pty ltd
 Level 4, 2 Glen Street
 Milsions Point NSW 2061
 Australia
 Telephone (02) 8904 1444
 Facsimile (02) 8904 1555
 www.enstruct.com.au







project
CANVA - SURRY HILLS
 8-24 KIPPAX STREET, SURRY HILLS 2010

drawing title
STORMWATER PLAN

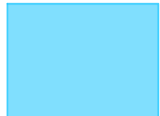
status			
FOR INFORMATION ONLY			
scale at A1 1:100	drawn MZV	checked PAL	approved NOV-23
project no. 7039	sheet 7039-CV-3001	rev. 03	

CATCHMENT LEGEND

-  Roof Area
Total Area = 680m²
-  Terrace Footpath Area
Total Area = 178m²
-  Landscaping/Planters Area
Total Area = 170m²
-  Bypass Area
Total Area = 6m²

Total Catchment Area = 1,034m²

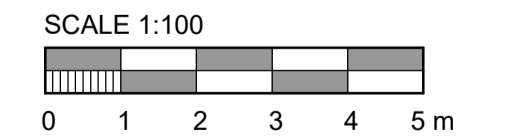
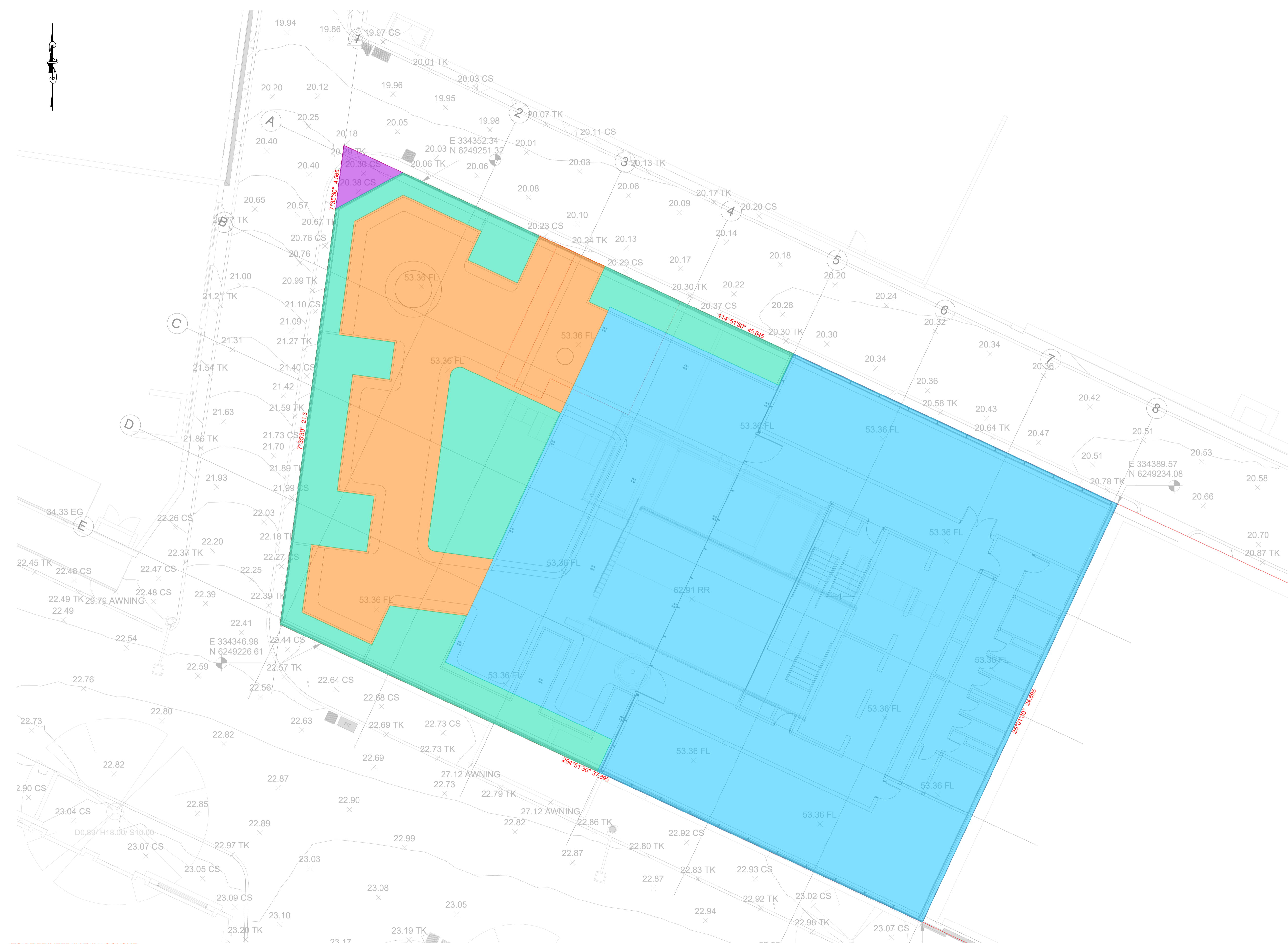

NOT FOR CONSTRUCTION

Date generated: 11/20/23 3:42:24 PM ULTRANSLATIONS\STRUCT\CAD\17000\03\CIVIL\DRAWINGS\7039-CV-3101

TO BE PRINTED IN FULL COLOUR

rev	date	description	dm	ch/k
01	01/12/23	ISSUE FOR DEVELOPMENT APPLICATION	MZV	PAL

rev	date	description	dm	ch/k

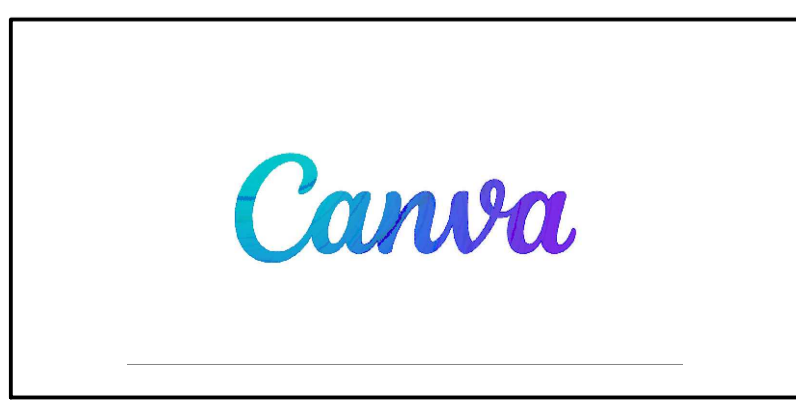

enstruct group pty ltd

Level 4, 2 Glen Street
Milsions Point NSW 2061
Australia

Telephone (02) 8904 1444
Facsimile (02) 8904 1555
www.enstruct.com.au



project	CANVA - SURRY HILLS
8-24 KIPPAX STREET, SURRY HILLS 2010	

drawing title	STORMWATER CATCHMENT PLAN
---------------	---------------------------

status	FOR INFORMATION ONLY			
scale at A1	drawn	checked	approved	
1:100	MZV	PAL	DEC-23	
project no.	sheet	rev.		
7039	7039-CV-3101	01		

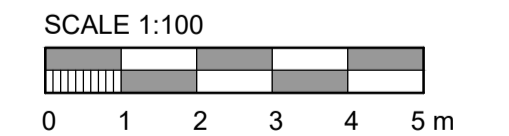
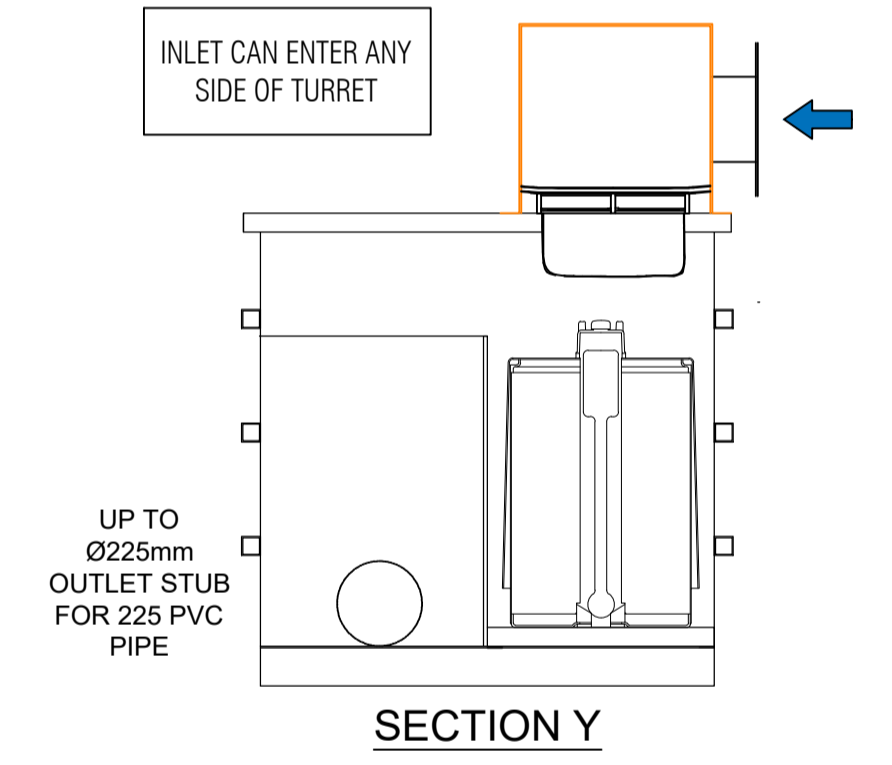
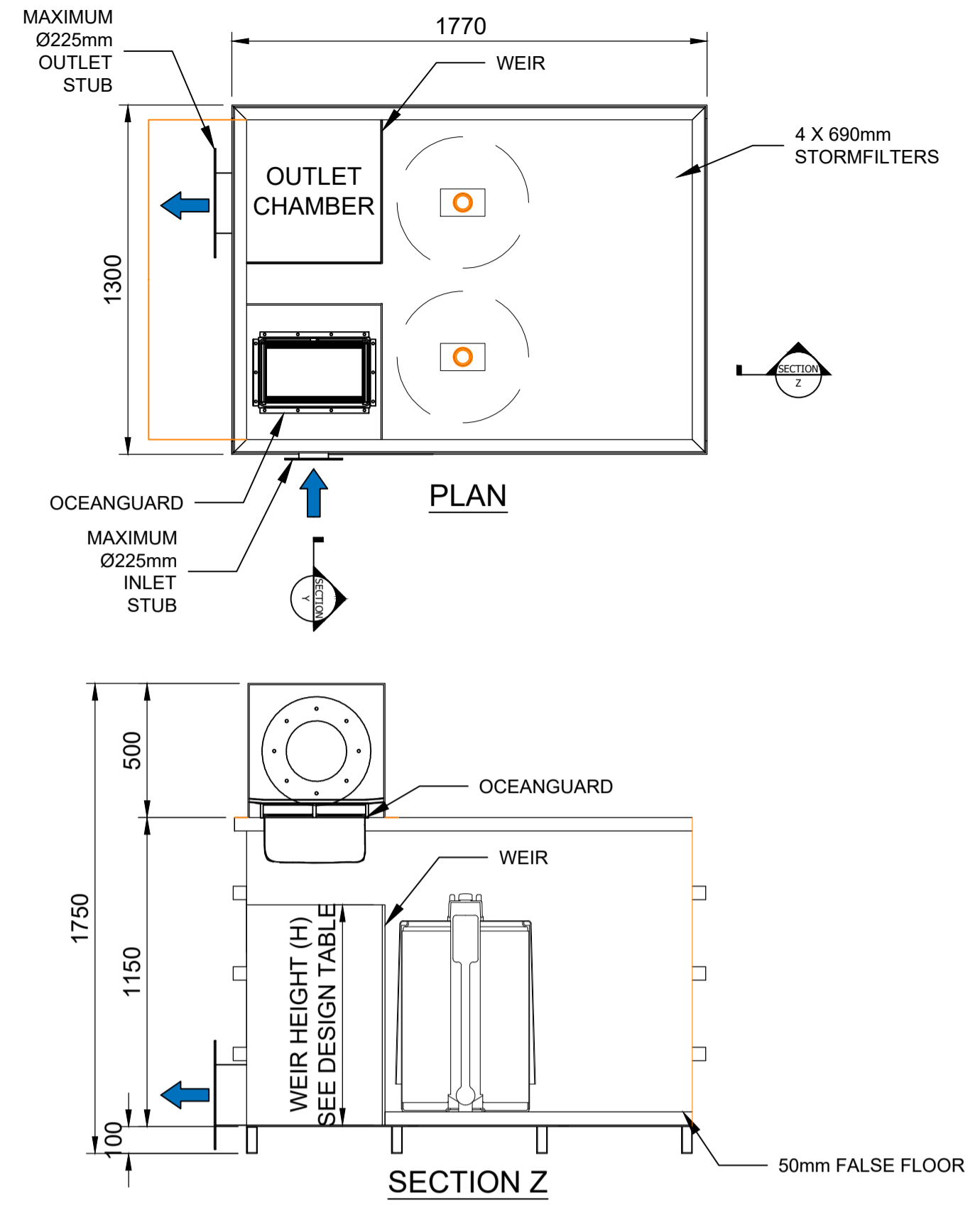

NOT FOR CONSTRUCTION

Date generated: 11/2/2023 3:28:01 PM I:\TRANSPORT\ENSTRUCT\CAD\17000\103\CIVIL\DRAWINGS\7039-CV-3501

TO BE PRINTED IN FULL COLOUR

rev	date	description	dm	ch/k
01	01/12/23	ISSUE FOR DEVELOPMENT APPLICATION	BEJ	PAL

rev	date	description	dm	ch/k

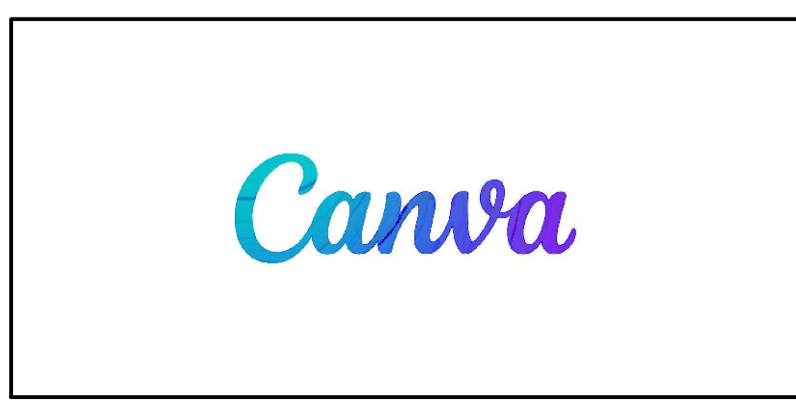

enstruct group pty ltd

Level 4, 2 Glen Street
Milsoms Point NSW 2061
Australia

Telephone (02) 8904 1444
Facsimile (02) 8904 1555
www.enstruct.com.au



project	CANVA - SURRY HILLS
8-24 KIPPAX STREET, SURRY HILLS 2010	

drawing title	DETAILS SHEET 1
---------------	-----------------

status			
FOR INFORMATION ONLY			
scale at A1	drawn	checked	approved
1:100	MZV	PAL	NOV-23
project no.	sheet	rev.	
7039	7039-CV-3501	01	

enstruct

CIVIL ENGINEERING WORKS

CANVA - SURRY HILLS

8-24 KIPPAX STREET, SURRY HILLS 2010

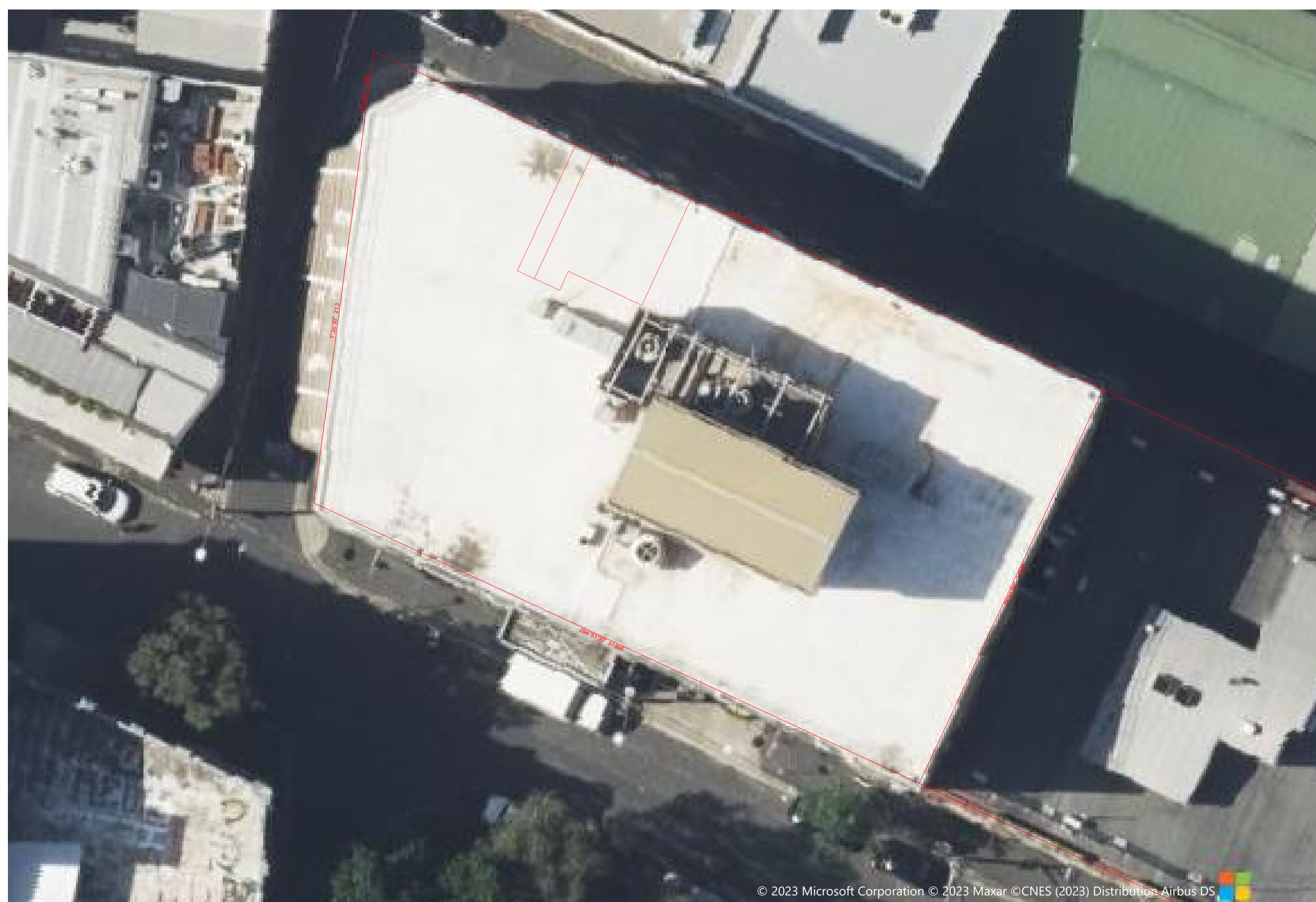

LOCALITY PLAN
SCALE: 1:200

© 2023 Microsoft Corporation © 2023 Maxar © CNES (2023) Distribution Airbus DS

CIVIL ENGINEERING WORKS DRAWING LIST:

- 7039-CV-0001 COVER SHEET, LOCALITY PLAN AND DRAWING LIST
- 7039-CV-0002 NOTES SHEET
- 7039-CV-2001 SITEWORKS PLAN
- 7039-CV-3001 STORMWATER PLAN
- 7039-CV-3051 STORMWATER CATCHMENT PLAN
- 7039-CV-3501 DETAILS SHEET 1

NOT FOR CONSTRUCTION

TO BE PRINTED IN FULL COLOUR

Date generated: 11/2/2023 3:07:46 PM I:\TRANSPORT\ENSTRUCT\CAD\17000\7039\CIVIL\DRAWINGS\7039-CV-0001

rev	date	description	dm	ch/k
01	01/12/23	ISSUE FOR DEVELOPMENT APPLICATION	MZV	PAL

rev	date	description	dm	ch/k

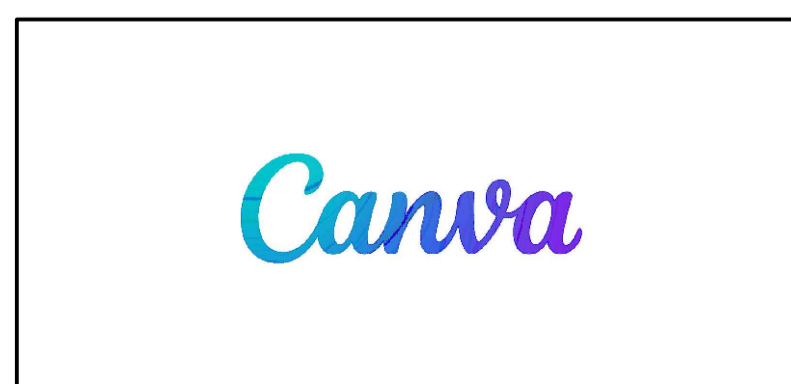

enstruct group pty ltd

Level 4, 2 Glen Street
Milsons Point NSW 2061
Australia

Telephone (02) 8904 1444
Facsimile (02) 8904 1555
www.enstruct.com.au



project	CANVA - SURRY HILLS
	8-24 KIPPAX STREET, SURRY HILLS 2010

drawing title	COVER SHEET, LOCALITY PLAN AND DRAWING LIST

status				FOR INFORMATION ONLY			
scale at A1	drawn	checked	approved				
N.T.S	MZV	PAL	DEC-23				
project no.	sheet		rev.				
7039	7039-CV-0001		01				

SURVEY AND SERVICES INFORMATION

SURVEY
 Origin of levels : PM53243 - 18.302m AHD
 Datum of levels : A.H.D. AUSTRALIAN HEIGHT DATUM
 Coordinate system : MGA-56
 Survey prepared by : C & A SURVEYORS
 Setout Points : CONTACT THE SURVEYOR

enstruct does not guarantee that the survey information shown on these drawings is accurate and will accept no liability for any inaccuracies in the survey information provided to us from any cause whatsoever.

UNDERGROUND SERVICES - WARNING

The locations of underground services shown on enstruct drawings have been plotted from diagrams provided by service authorities. This information has been prepared solely for the authorities own use and may not necessarily be updated or accurate.

The position of services as recorded by the authority at the time of installation may not reflect changes in the physical environment subsequent to installation.

enstruct does not guarantee that the services information shown on these drawings shows more than the presence or absence of services, and will accept no liability for inaccuracies in the services information shown from any cause whatsoever.

The Contractor must confirm the exact location and extent of services prior to construction and notify any conflict with the drawings immediately to the Engineer/Superintendent.

The contractor is to get approval from the relevant state survey department, to remove/adjust any survey mark. This includes but is not limited to; State Survey Marks (SSM), Permanent Marks (PM), cadastral reference marks or any other survey mark which is to be removed or adjusted in any way.

enstruct plans do not indicate the presence of any survey mark. The contractor is to undertake their own search.

SITWORKS NOTES

- All basecourse material to comply with RMS specification No 3051 and compacted to minimum 98% modified dry density in accordance with AS 1289 5.2.1.
- All trench backfill material shall be compacted to the same density as the adjacent material.
- All service trenches under vehicular pavements shall be backfilled with an approved select material and compacted to a minimum 98% standard maximum dry density in accordance with AS 1289 5.1.1

DBYD SERVICES NOTE

"Public Service Utility information shown on plan has been compiled from information received from Dial Before You Dig inquiry, reference Number 35269078, which was obtained on 17/10/2023. Unless specifically shown otherwise, this location and depth of services shown on this plan have not been verified.

The location of services shown on this drawing have been plotted as accurately as possible from diagrams provided by service authorities and should be confirmed by site inspection."

GENERAL NOTES

- Contractor must verify all dimensions and existing levels on site prior to commencement of works. Any discrepancies to be reported to the Superintendent
- Strip all topsoil from the construction area. All stripped topsoil shall be disposed of off-site unless directed otherwise.
- Make smooth connection with all existing works.
- Compact subgrade under buildings and pavements to minimum 98% standard maximum dry density in accordance with AS 1289 5.1.1. Compaction under buildings to extend 2m minimum beyond building footprint.
- All work on public property, property which is to become public property, or any work which is to come under the control of the Statutory Authority; the Contractor is to ensure that the drawings used for construction have been approved by all relevant authorities prior to commencement site.
- All work on public property, property which is to become public property, or any work which is to come under the control of the Statutory Authority is to be carried out in accordance with the requirements of the relevant Authority. The Contractor shall obtain these requirements from the Authority. Where the requirements of the Authority are different to the drawings and specifications, the requirements of the Authority shall be applicable.
- For all temporary batters refer to geotechnical recommendations.
- The approval of a substation shall be sought from the superintendent but is not an authorisation of a cost variation. The superintendent must approve any cost variation before any work starts

REFERENCE DRAWINGS

- These drawings have been based from, and to be read in conjunction with the following Consultants drawings. Any conflict to the drawings must be notified immediately to the Engineer.

Consultant	Dwg Title	Dwg No	Rev	Date
COX	General Arrangement Plan	DA1-2100	1	05/12/23
		DA1-2101	1	05/12/23
		DA1-2102	1	05/12/23
		DA1-2106	1	05/12/23

STORMWATER DRAINAGE NOTES

- Stormwater Design Criteria :
 - (A) Average exceedance probability - 1% AEP for roof drainage to first external pit
 - (B) Rainfall intensities - Time of concentration: 5 minutes
 - 1% AEP = 260 mm/hr
 - 5% AEP = 200 mm/hr
 - (C) Rainfall losses - Impervious areas: IL= 1.0 mm , CL = 0 mm/hr Pervious areas: IL= 28mm , CL = 1.6 mm/hr
- Pipes up to 225 dia may be sewer grade uPVC with solvent welded joints, subject to approval by the engineer
- Enlargers, connections and junctions to be manufactured fittings where pipes are less than 300 dia.
- Pipes are to be installed in accordance with AS 3725. All bedding to be type H2 U.N.O.
- Pit grates and covers shall conform with AS3996-2006, and AS1428.1 for access requirements.

EROSION AND SEDIMENT CONTROL NOTES

- All work shall be generally carried out in accordance with
 - (A) Local authority requirements,
 - (B) EPA - Pollution control manual for urban stormwater,
 - (C) LANDCOM NSW - Managing Urban Stormwater: Soils and Construction ("Blue Book").
- Erosion and sediment control drawings and notes are provided for the whole of the works. Should the Contractor stage these works then the design may be required to be modified. Variation to these details may require approval by the relevant authorities. The erosion and sediment control plan shall be implemented and adapted to meet the varying situations as work on site progresses.
- Maintain all erosion and sediment control devices to the satisfaction of the superintendent and the local authority.
- Minimise the area of site being disturbed at any one time.
- All soil and water control measures are to be put back in place at the end of each working day, and modified to best suit site conditions.
- Control water from upstream of the site such that it does not enter the disturbed site.
- All vehicles leaving the site shall be cleaned and inspected before leaving.
- Maintain all stormwater pipes and pits clear of debris and sediment. Inspect stormwater system and clean out after each storm event.
- Clean out all erosion and sediment control devices after each storm event.

Sequence Of Works

- Prior to commencement of excavation the following soil management devices must be installed:
 - Construct silt fences below the site and across all potential runoff sites.
 - Construct measures to divert upstream clean flows into existing stormwater system.
 - Provide sandbag sediment traps upstream of existing pits.
- Construct geotextile filter pit surround around all existing pits and proposed pits as they are constructed.

WATER QUALITY TESTING REQUIREMENTS

Prior to discharge of site stormwater, groundwater and seepage water into council's stormwater system, contractors must undertake water quality tests in conjunction with a suitably qualified environment consultant outlining the following:

- Compliance with the criteria of the Australian and New Zealand Guidelines for Fresh and Marine Water Quality (2000)
- If required subject to the environmental consultants advice, provide remedial measures to improve the quality of water that is to be discharged into Councils storm water drainage system. This should include comments from a suitably qualified environmental consultant confirming the suitability of these remedial measures to manage the water discharged from the site into Councils storm water drainage system. Outlining the proposed, ongoing monitoring, contingency plans and validation program that will be in place to continually monitor the quality of water discharged from this site. This should outline the frequency of water quality testing that will be undertaken by a suitably qualified environmental consultant.

TO BE PRINTED IN FULL COLOUR

NOT FOR CONSTRUCTION

rev	date	description	dm	ch'k
02	07/12/23	ISSUE FOR DEVELOPMENT APPLICATION	MZV	PAL
01	01/12/23	ISSUE FOR DEVELOPMENT APPLICATION	MZV	PAL

rev	date	description	dm	ch'k

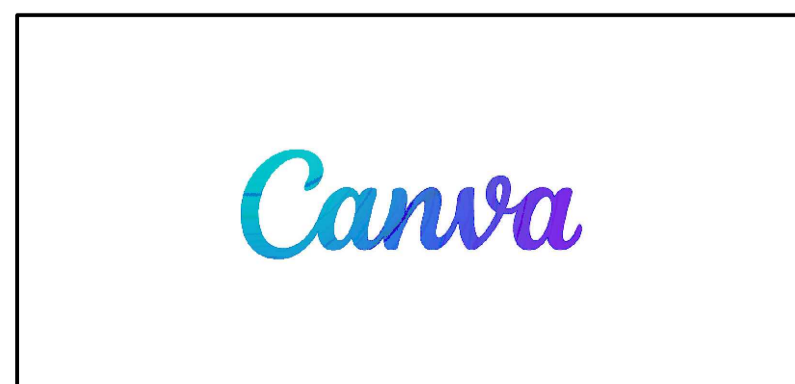

enstruct group pty ltd

Level 4, 2 Glen Street
 Milsons Point NSW 2061
 Australia

Telephone (02) 8904 1444
 Facsimile (02) 8904 1555
 www.enstruct.com.au





project	CANVA - SURRY HILLS
8-24 KIPPAX STREET, SURRY HILLS 2010	

drawing title	NOTES SHEET
---------------	--------------------

status			
FOR INFORMATION ONLY			
scale at A1	drawn	checked	approved
N.T.S	MZV	PAL	DEC-23
project no.	sheet	rev.	
7039	7039-CV-0002	02	

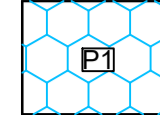
PAVEMENT LEGEND

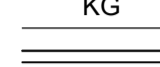
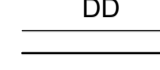
-  Pavement Type 1: Pavers to City of Sydney Specification.
-  Pavement Type 2: Pavers to City of Sydney Specification. Pavement constructed as a part of City of Sydney Terry Street Shared Zone.
-  PROPOSED KERB AND GUTTER
-  PROPOSED DISH DRAIN

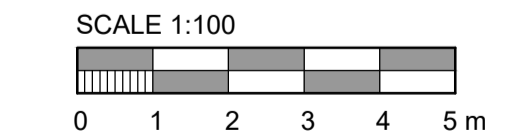

NOT FOR CONSTRUCTION

Date generated: 7/12/2023 8:48:22 AM | UTTRANSITIONENSTRUCTCAD0170007039CV001 | CIVILDRAWINGS/039-CV-2001

TO BE PRINTED IN FULL COLOUR

rev	date	description	drm	ch/k
03	07/12/23	ISSUE FOR DEVELOPMENT APPLICATION	MZV	PAL
02	01/12/23	ISSUE FOR DEVELOPMENT APPLICATION	BEJ	PAL
01	27/11/23	ISSUE FOR INFORMATION	BEJ	PAL

rev	date	description	drm	ch/k

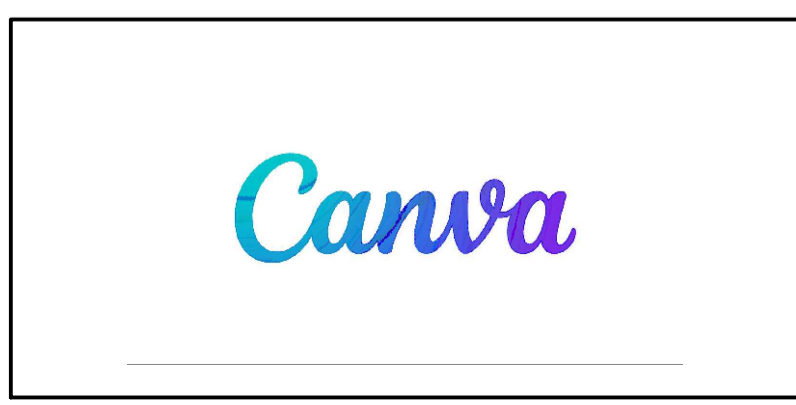

enstruct group pty ltd
 Level 4, 2 Glen Street
 Milsions Point NSW 2061
 Australia
 Telephone (02) 8904 1444
 Facsimile (02) 8904 1555
 www.enstruct.com.au



project
CANVA - SURRY HILLS
 8-24 KIPPAX STREET, SURRY HILLS 2010

drawing title
SITE WORKS PLAN

status			
FOR INFORMATION ONLY			
scale at A1 1:100	drawn MZV	checked PAL	approved NOV-23
project no. 7039	sheet 7039-CV-2001	rev. 03	

SITeworks LEGEND

- Property boundary
- Dish drain
- Proposed stormwater line and stormwater pit
- Concrete encased stormwater line
- Existing stormwater line
- Overland flow path

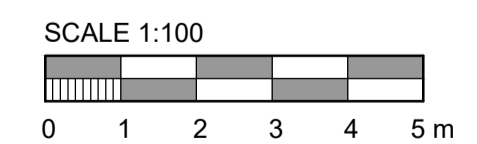

NOT FOR CONSTRUCTION

Date generated: 4/12/2023 11:27:25 AM | UTILITY/TRANSITION/STRUCTURE/03-CV-3001 | UTILITY/TRANSITION/STRUCTURE/03-CV-3001

TO BE PRINTED IN FULL COLOUR

rev	date	description	dm	ch/k
03	07/12/23	ISSUE FOR DEVELOPMENT APPLICATION	MZV	PAL
02	01/12/23	ISSUE FOR DEVELOPMENT APPLICATION	MZV	PAL
01	27/11/23	ISSUE FOR INFORMATION	BEJ	PAL

rev	date	description	dm	ch/k

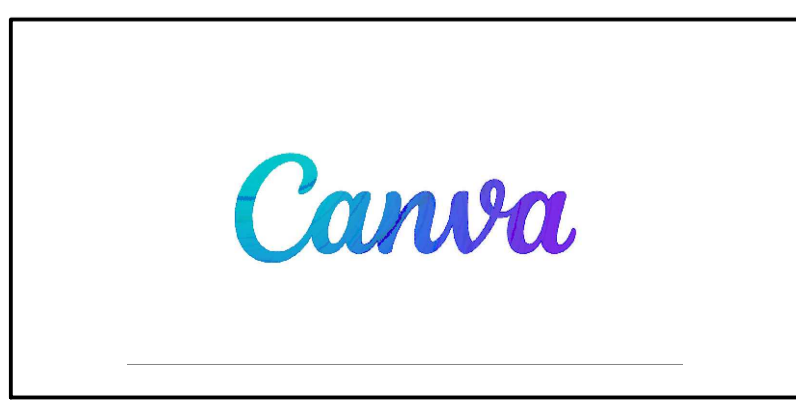

enstruct group pty ltd
 Level 4, 2 Glen Street
 Milsions Point NSW 2061
 Australia
 Telephone (02) 8904 1444
 Facsimile (02) 8904 1555
 www.enstruct.com.au





project
CANVA - SURRY HILLS
 8-24 KIPPAX STREET, SURRY HILLS 2010

drawing title
STORMWATER PLAN

status			
FOR INFORMATION ONLY			
scale at A1 1:100	drawn MZV	checked PAL	approved NOV-23
project no. 7039	sheet 7039-CV-3001	rev. 03	

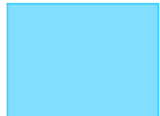
CATCHMENT LEGEND

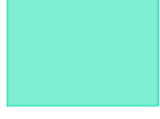
-  Roof Area
Total Area = 680m²
-  Terrace Footpath Area
Total Area = 178m²
-  Landscaping/Planters Area
Total Area = 170m²
-  Bypass Area
Total Area = 6m²

Total Catchment Area = 1,034m²

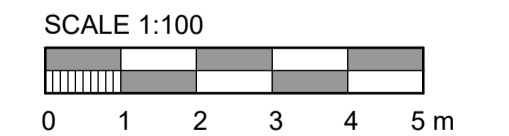
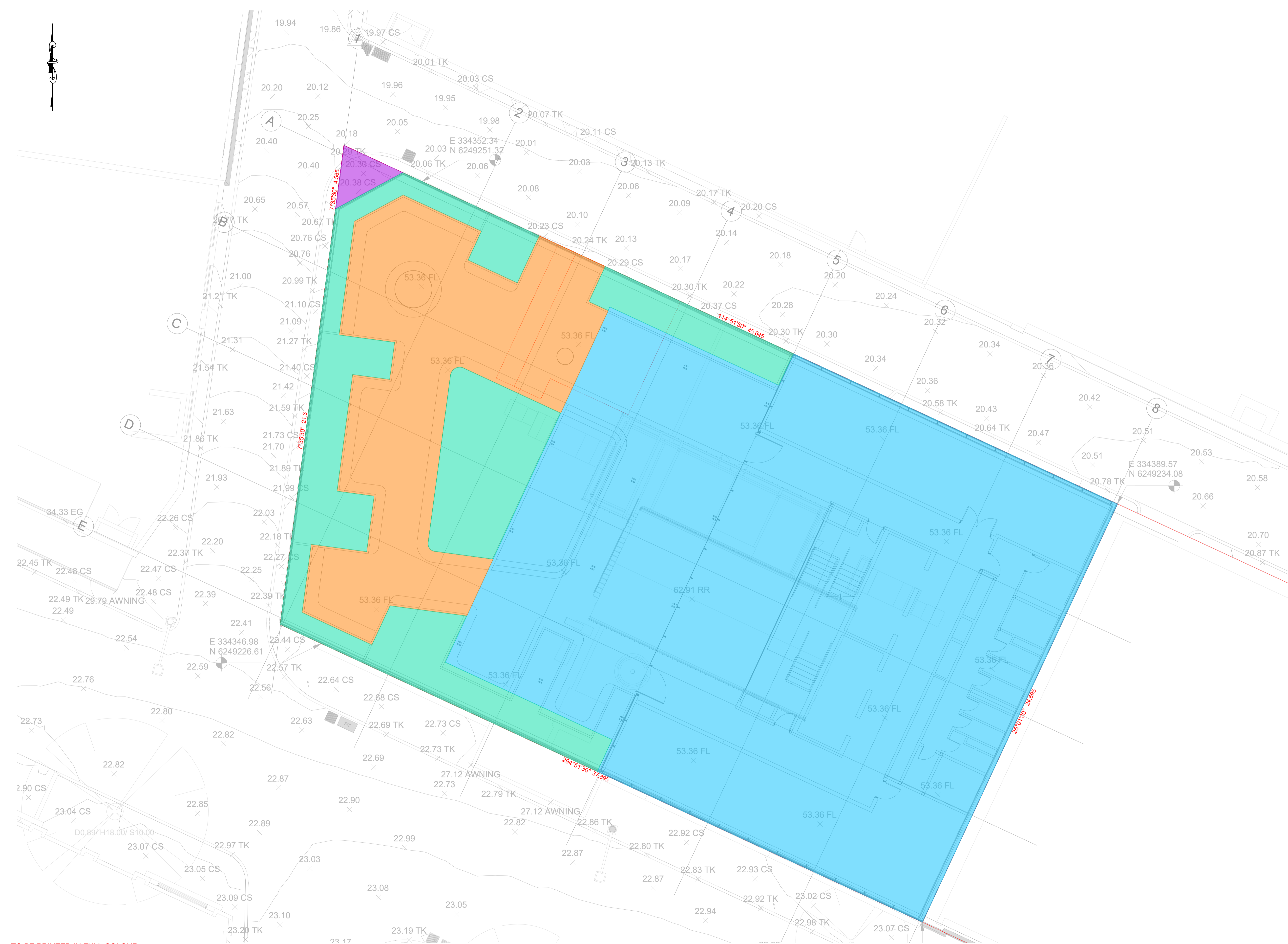

NOT FOR CONSTRUCTION

Date generated: 11/20/23 3:42:24 PM U:\TRANSPORT\STRUCTURE\CAD\17000\103\CV\DRAWINGS\7039-CV-3101

TO BE PRINTED IN FULL COLOUR

rev	date	description	dm	ch/k
01	01/12/23	ISSUE FOR DEVELOPMENT APPLICATION	MZV	PAL

rev	date	description	dm	ch/k

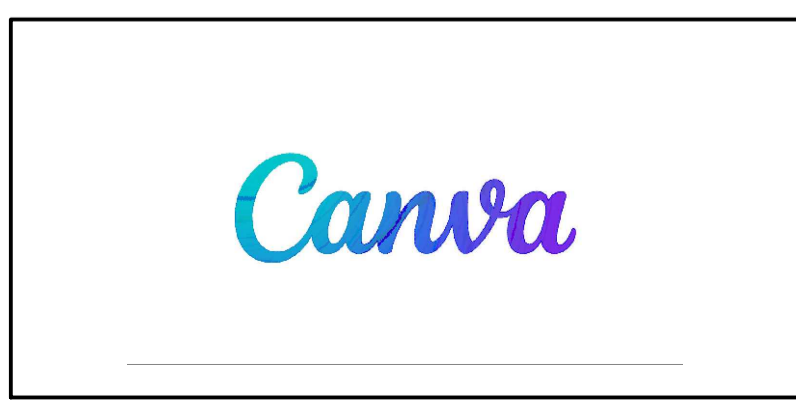

enstruct group pty ltd

Level 4, 2 Glen Street
Milsions Point NSW 2061
Australia

Telephone (02) 8904 1444
Facsimile (02) 8904 1555
www.enstruct.com.au



project	CANVA - SURRY HILLS
8-24 KIPPAX STREET, SURRY HILLS 2010	

drawing title	STORMWATER CATCHMENT PLAN
---------------	---------------------------

status	FOR INFORMATION ONLY			
scale at A1	drawn	checked	approved	
1:100	MZV	PAL	DEC-23	
project no.	sheet	rev.		
7039	7039-CV-3101			01

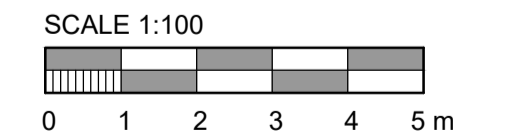
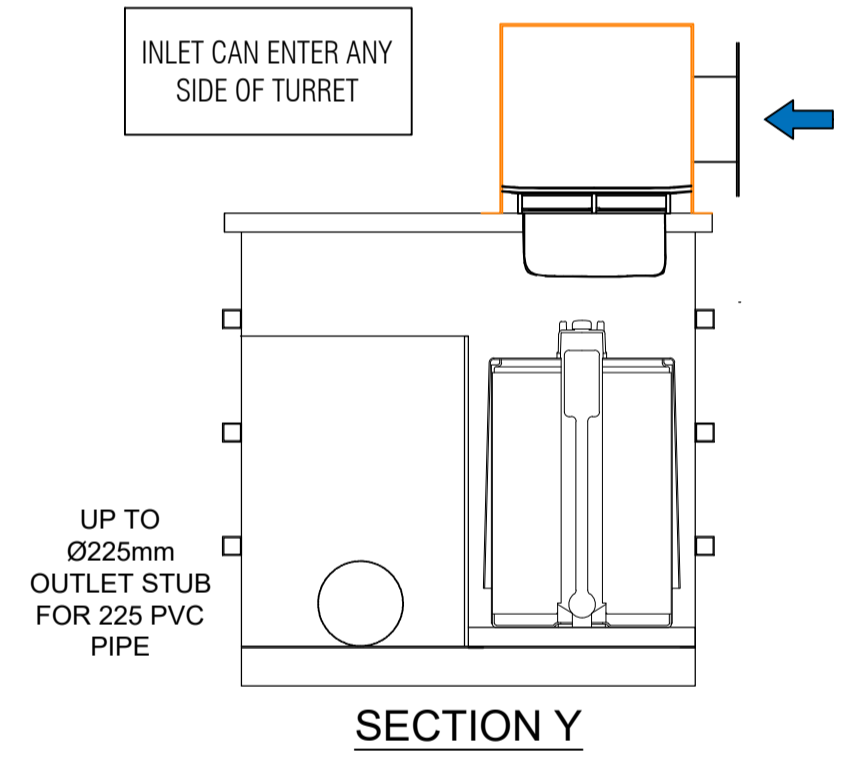
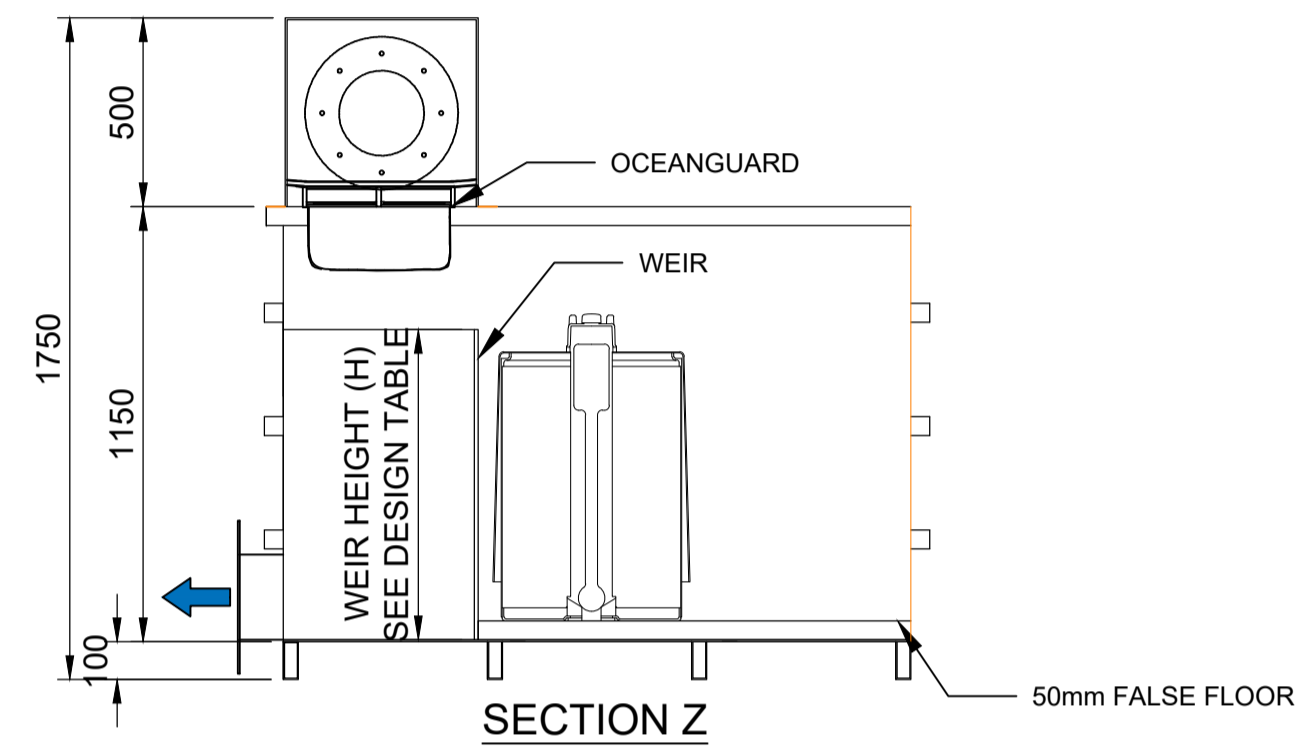
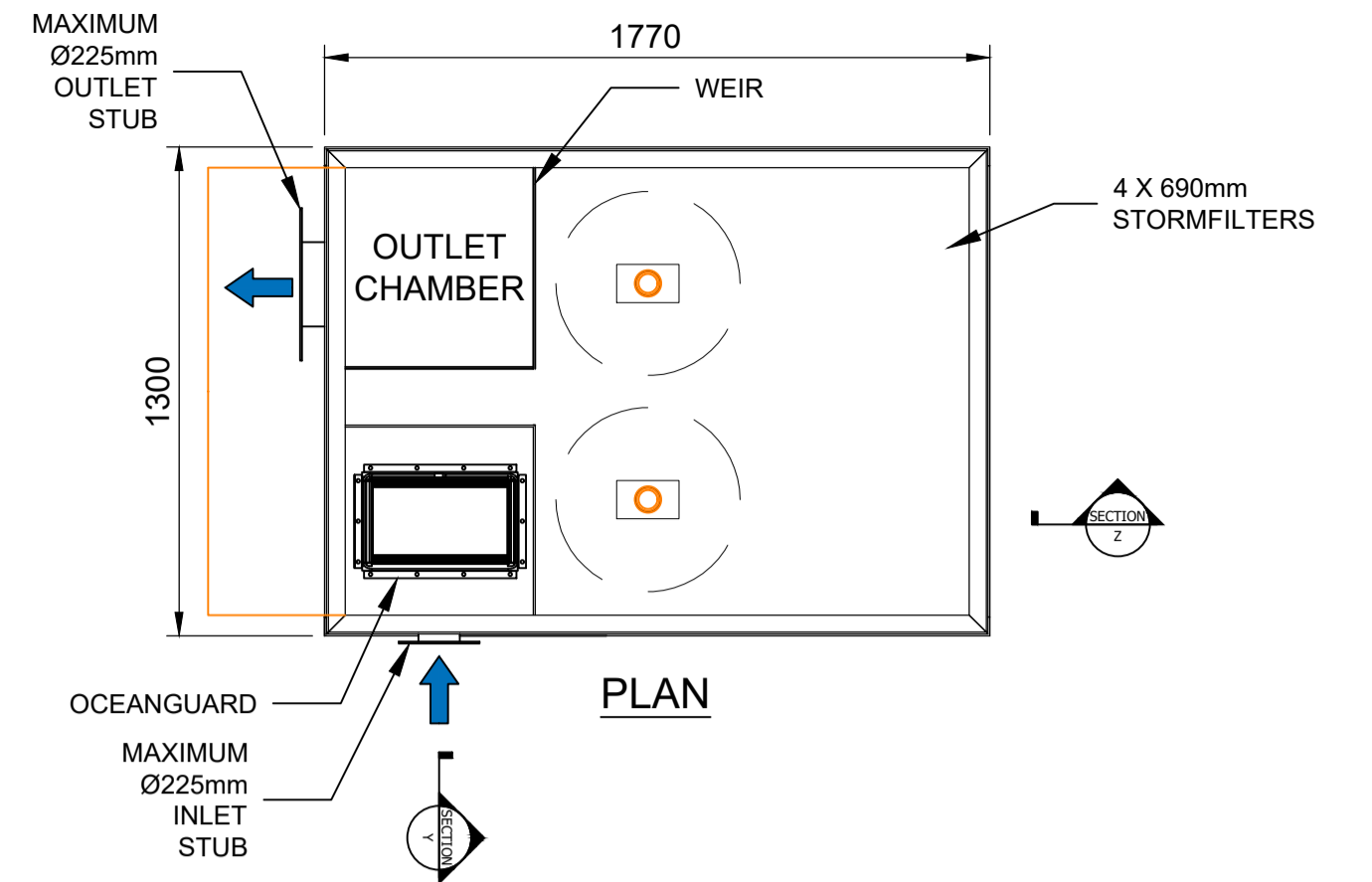

NOT FOR CONSTRUCTION

Date generated: 11/2/2023 3:28:01 PM I:\TRANSPORT\ENSTRUCT\CAD\17000\103\CIVIL\DRAWINGS\7039-CV-3501

TO BE PRINTED IN FULL COLOUR

rev	date	description	dm	ch/k
01	01/12/23	ISSUE FOR DEVELOPMENT APPLICATION	BEJ	PAL

rev	date	description	dm	ch/k

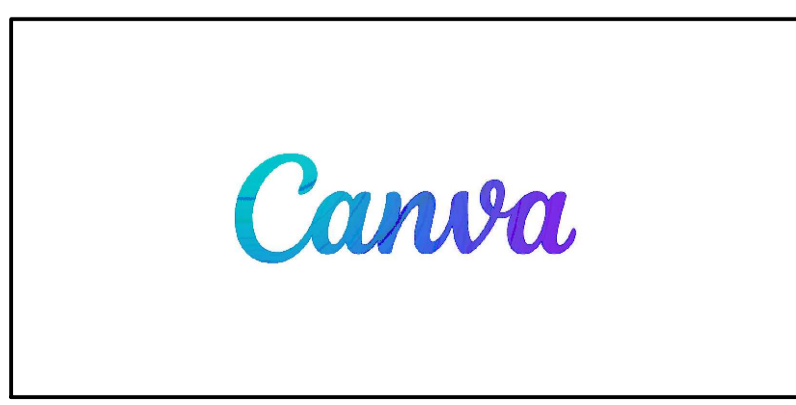

enstruct group pty ltd

Level 4, 2 Glen Street
Milsoms Point NSW 2061
Australia

Telephone (02) 8904 1444
Facsimile (02) 8904 1555
www.enstruct.com.au



project	CANVA - SURRY HILLS
8-24 KIPPAX STREET, SURRY HILLS 2010	

drawing title	DETAILS SHEET 1
---------------	-----------------

status			
FOR INFORMATION ONLY			
scale at A1	drawn	checked	approved
1:100	MZV	PAL	NOV-23
project no.	sheet	rev.	
7039	7039-CV-3501	01	